



TBMR-110M

DC - 110 MHz high speed EMI-Analyzer

Operating Manual

Rev.1.0

Certification

TekBox certifies that this product met the published specifications at the time of shipment from the factory.

Warranty

This product is warranted against defects in material and workmanship for a period of 2 years from the date of delivery. During this warranty period, TekBox will, at its own option, either repair or replace products which prove to be defective. For warranty service or repair, this product must be returned to the TekBox electronics factory or to the distributor, where the product was purchased.

TekBox warrants that its software and firmware designated by TekBox for use with the instrument will execute its programming instructions when properly installed on the PC. TekBox does not warrant that the operation of the instrument, or software, or firmware will be uninterrupted or error free. The foregoing warranty shall not apply to defects resulting from improper or inadequate maintenance by the Buyer, Buyer supplied software or interfacing, unauthorized modification or misuse, operation outside the environmental specifications for the product, or improper site preparation or maintenance.

No other warranty is expressed or implied. TekBox specifically disclaims the implied warranties of merchantability and fitness for a particular purpose. The remedies provided herein are the Buyer's sole and exclusive remedies. TekBox shall not be liable for any direct, indirect, special, incidental, or consequential damages, whether based on contract, tort, or any legal theory.

Compliance and Calibration

European Union

Standard

EN 61326-1:2013

EN 61326-2-1:2013

EN 61010-1:2010/A1:2019/AC:2019-04

EN 61010-2-081:2020

EN 63000:2018

Title

Electrical equipment for measurement, control and laboratory use

– EMC requirements, Part 1: General requirements

Electrical equipment for measurement, control and laboratory use

– EMC requirements, Part 2-1: Particular requirements

Safety requirements for electrical equipment for measurement, control and laboratory use, Part 1: General requirements

Safety requirements for electrical equipment for measurement, control and laboratory use, Part 2-081: Particular requirements for automatic and semi-automatic laboratory equipment for analysis and other purposes

Technical documentation for the assessment of electrical and electronic products with respect to the restriction of hazardous substances

Additional, country specific conformity declarations are available through our distributors.

Recommended calibration period: 1 year, if the instrument is used permanently in an industrial environment; 2 years if it is used occasionally in a laboratory environment.

Safety

GENERAL SAFETY INSTRUCTIONS

Carefully read through the following chapters before powering and operating the measurement receiver. Observe all the precautions and warnings provided in this manual for all the phases of operation, service and repair of the Analyzer. The Analyzer must be used only by skilled and specialized staff or well-trained personnel with the necessary skills and knowledge of safety precautions. The Analyzer is an IEC-61010 CAT I device, there for no measurements shall be done involving a CAT II, III or IV environment. Operators must not remove the covers or parts of the housing. The Analyzer must not be repaired by the operator. Component replacement or internal adjustment shall only be performed by qualified maintenance personnel only.

Operating Environment

The measurement receiver is intended for indoor use and should be operated in a clean and dry environment.

- Operating temperature range: 0 °C to +40 °C
- Operating humidity range: max. 85% RH, 24 hrs.
- Operating altitude range: ≤ 3000 m
- Storage temperature range: -20 °C to +60 °C
- Storage humidity range: max 85% RH, 24 hrs.

Note: Avoid direct sunlight, radiators and other heat sources in the vicinity of the instrument. The instrument relies on forced air cooling with internal fans and ventilation openings. Avoid restricting the airflow at the fan and ventilation openings. Keep away liquids and inflammable gases.

AC MAINS SUPPLY VOLTAGE

The measurement receiver contains a linear power supply and does not automatically adapt to line voltage. The instrument is pre-set to the local mains voltage at its expected destination. However, before first operation, ensure that the mains voltage indicated at the mains voltage selector switch at the rear panel of the instrument matches your local mains voltage.

- 100 V_{RMS} – 120 V_{RMS} (± 3%) 50/60 Hz (± 5%)
- 200 V_{RMS} – 240 V_{RMS} (± 3%) 50/60 Hz (± 5%)



Warning: Manual mains voltage selection is required

Ensure that the mains voltage selector switch is set correctly to avoid damaging the instrument.

POWER AND GROUND CONNECTIONS

The instrument is supplied together with a country specific AC power cord. The AC power cord contains a molded, three-terminal, country specific plug and a standard IEC320 (Type C13) connector for making line voltage and protective earth connection. The mating IEC320 (Type C13) AC socket earth terminal is connected directly to the metal chassis of the instrument. For adequate protection against electrical shock hazard, the power plug must be inserted into a mating AC mains outlet containing protective earth contact. Use only the power cord specified for this instrument and specified for the country of use. Use the instrument only in installations protected with a ground fault switch.

Do not use excessive force on connecting cables to any connector of the instrument. The power cord should be unplugged from the AC outlet, if the instrument is not to be used for an extended period of time.

	<p>Warning: Electrical Shock Hazard</p> <p>Any interruption of the protective earth conductor within or outside of the instrument or disconnection of the protective earth terminal creates a hazardous situation with the potential of lethal electrical shock.</p> <p>Intentional disruption is prohibited.</p>
--	--

	<p>Caution:</p> <p>The outer shells of the N-connectors at the front panel of the instrument are connected to the instrument's chassis and therefore to protective earth.</p>
---	--

CLEANING

Clean only the exterior of the instrument. Use a damp, soft cloth for cleaning. Do not use any chemicals or abrasive sponges. Under no circumstances allow moisture or liquid to penetrate the instrument. To avoid electrical shock, the power cord must be unplugged from the instrument before cleaning.

	<p>Warning: Electrical Shock Hazard</p> <p>Disconnect the power cord, before cleaning the instrument. Do not remove covers when cleaning the instrument. Ensure that no moisture entered the instrument, before re-connecting it to AC mains.</p>
---	--

ABNORMAL CONDITIONS

Do not operate the instrument, if there are any visible signs of damage, abnormal smell or sound. In case that you suspect that the instrument's protection has been impaired, disconnect the power cord and secure the instrument against any unintended operation.

Only operate the instrument for the purposes specified by the operator. Do not connect the instrument directly to human subjects or for medical monitoring.

ESD PROTECTION

Electrostatic discharge can damage the instrument when connected or disconnected from the Equipment Under Test. Static charge can build up on the body and damage the sensitive circuits of internal components of both the instrument and the EUT.

To avoid damage, operate the instrument in an ESD-safe environment or wear a grounding wrist strap connected to the desktop anti-static mat via daisy-chained 1 M Ω resistor.

RF-INPUT PROTECTION

RF-Inputs are sensitive and can be damaged by excessive power or voltage transients.

The maximum input rating of the instrument is + 30 dBm at an internal attenuation setting of 30 dB. Note that the input rating decreases with decreased internal attenuation or increased internal gain settings accordingly.

Before connecting the RF-input of the instrument to a RF-Source or to an Equipment Under Test, make sure that the internal settings are set to achieve the maximum input rating and only thereafter gradually modify the instrument settings to achieve the required dynamic range. Any excessive input power or voltage will cause the instrument to issue an optical and acoustical input overflow warning.

If you connect the instrument to an unknown source or Equipment Under Test, protect the RF-input with an attenuator / high-pass filter / limiter such as Tekbox TBFL1. Make yourself familiar with the input protection products offered on the Tekbox website.



Warning: RF-Input overload

Be cautious when connecting any unknown source to the RF-input. Carefully study the related information of this manual to avoid damage of the RF frontend circuitry.

Contents

1	Introduction to the TBMR-110M EMI analyzer	8
1.1	Introduction.....	8
1.2	Application Overview	10
1.2.1	EMI Analyzer.....	10
1.2.2	Spectrum Analyzer	11
1.2.3	Tracking Analyzer	11
1.2.4	Oscilloscope.....	12
1.2.5	Demodulator	12
1.2.6	Remote Control	13
1.2.7	Stream I/Q data.....	13
1.3	System Requirements.....	14
1.4	Packaging List	14
1.5	Unpacking and Preparations for First Use.....	14
1.6	Software Installation	17
1.7	First Power - On.....	17
2	Operation	21
2.1	Front Panel Elements.	21
2.2	Theory of Operation	22
2.3	Starting the Software	24
2.4	EMI Analyzer Application	26
2.5	Spectrum Analyzer Application	34
2.6	Tracking Analyzer Application	40
2.7	Oscilloscope Application	43
2.8	Demodulator Application	46
2.9	Remote Control Application	48
2.10	I/Q Data Streaming Application.....	51
3	Appendix.....	52
3.1	EMI measurement correction – Transducer characteristics	52
3.2	Compensation File Format	53
3.3	Project File Format	54
3.4	Limit File Format.....	56
3.5	Equation Syntax.....	58

3.6	The Diagram System.....	60
3.6.1	Move and glue the diagram to other windows.....	60
3.6.2	Print, Copy and Save diagrams.....	61
3.6.3	Diagram Properties.....	61
3.6.4	Quick Diagram Setup.....	66
3.6.5	Trace selection and Trace Context Menu.....	67
3.6.6	Legend	68
3.6.7	Label	69
3.6.8	Pan.....	70
3.6.9	Zooming.....	71
3.6.10	Scaling.....	72
3.6.11	Markers.....	73
3.7	Remote Control Commands	80
4	Specifications.....	86
5	Ordering Information	87
6	History	87

1 Introduction to the TBMR-110M EMI analyzer

1.1 Introduction

International EMC Standards require various spectrum measurement methods and equipment to ensure that the EUT's electromagnetic emissions do not exceed the specified limits. The TBMR-110M EMI Analyzer is designed to carry out conducted emission measurements. Its affordability and versatility make it a perfect tool for engineers doing pre-compliance measurements during the development process. Its ease of use also enables importers of electronic items to periodically assess if their suppliers supply consistent quality in terms of EMC compliance, without having to outsource it to test laboratories. High accuracy, versatility and high-speed measurements are only a few of the many features.

Main Features:

- EMI Analyzer DC-110 MHz (Measurement Receiver)
 - -162 dBm/Hz noise floor down to 1 kHz
 - 7-band hardware pre-selector filter bank.
 - 30 dBm maximum input power
 - CISPR-16, ANSI and MIL-STD compliant detectors
 - Peak, Quasi-Peak, Average, CISPR-Average, RMS and CISPR-RMS detectors working in parallel.
 - Sweep, STFFT and direct parallel resolution bandwidth setting (-3 dB and -6dB)
 - Numerous predefined Standards, ready to load and use
 - Pre-measurement with selective Peak measurement
 - Direct fast compliant STFFT measurement
 - Many pre-defined transducers, antenna factors and various other compensation files
 - Many data manipulation, display and documentation features
 - Direct control from EMCview or standalone operation
 - Quick load of predefined setups

- Spectrum Analyzer
 - True DC - 110 MHz measurement range
 - Tracking Generator
 - 0.1 Hz to 3.5 MHz arbitrary RBW and VBW setting
 - Zero Span operation with time domain triggering
 - Linear, log amplitude and frequency display
 - Sweep, STFFT and direct parallel resolution bandwidth setting
 - Parallel RMS, Pos./Neg. peak and average detector
 - Trace Memory option, normalization
 - Equation based trace display
 - Peak hold

- Noise marker, max and band power display
- Quick load of predefined setups

- Tracking Analyzer DC - 110 MHz
 - Linear and logarithmic sweep
 - -50 dBm to 0 dBm adjustable TG power
 - 120 dB dynamic range
 - Use of power correction file and level correction file
 - Quick load of predefined setups.

- Oscilloscope 250 MS/s, DC - 110 MHz
 - 1 ns/DIV to 1 s/DIV horizontal resolution
 - Interpolated sampling up to 4 GS/s
 - Real-time Sampling up to 250 MS/s, 14 Bit
 - Up to 16 MS sampling size
 - Various Trigger options
 - Vertical CIC Filter option for noise reduction
 - Many automatic measurement features

- Demodulator
 - Direct demodulation into the PC sound system
 - FM, AM and SSB demodulator
 - Adjustable bandwidth, center frequency and demodulator parameters
 - Automatic demodulation parameter measurements

- IQ Stream Generator
 - GNU-Radio data source.
 - Directly stream floating point I and Q data into file or network
 - Adjustable center frequency and bandwidth

- Remote Control
 - Direct remote control of the EMI Analyzer over network
 - Text based protocol
 - EMCview compatible

1.2 Application Overview

After launching the TBMR-110M software, a primary window with a variety of apps appears:

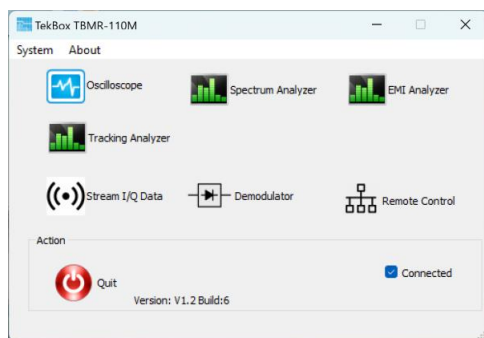

Figure 1-1 TBMR-110M software, primary window

1.2.1 EMI Analyzer

Measurement receiver, DC to 110 MHz, for conducted emission measurements, based on equipment specifications defined in CISPR 16, and MIL-STD-461G.

All common standards are predefined. Customized standards can be created and added by the user.

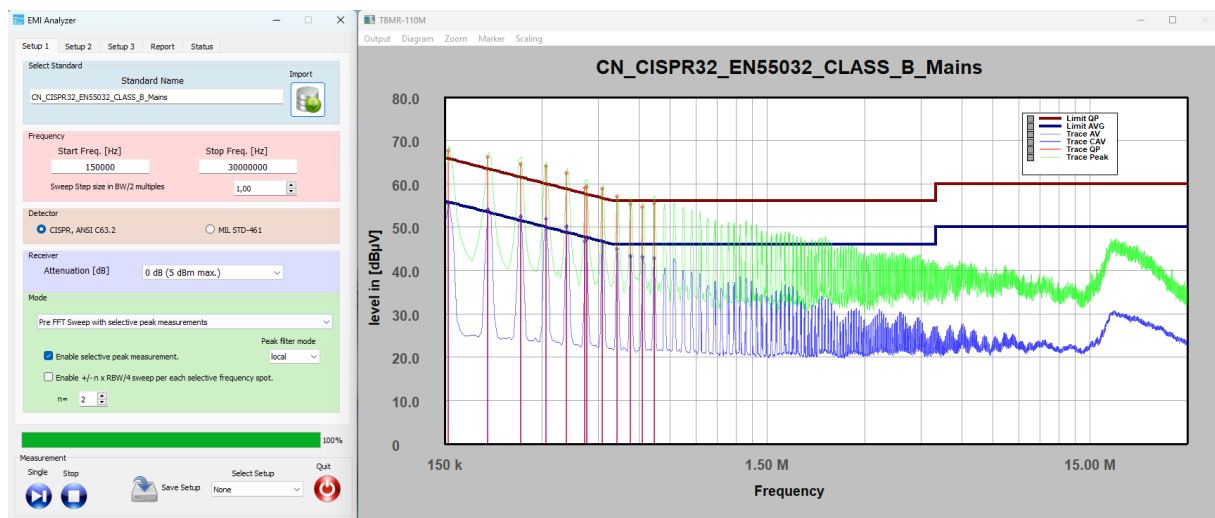

Figure 1-2 Measurement example

Figure 1-2 shows a conducted emission measurement, using CISPR 32 Class B limits for mains supply lines. An initial measurement using Peak and Average detector was followed by an automatic post-measurement with Quasi-Peak and CISPR-Average detector. The entire measurement, using FFT, took approximately 20 seconds.

A Direct FFT full compliance measurement from 150 kHz to 30 MHz, using only Quasi-Peak and CISPR Average detector would only take approximately 80 seconds.

1.2.2 Spectrum Analyzer

Spectrum analyzer, DC to 110 MHz, standard sweep mode, parallel sweep mode or STFFT with 3.5 MHz real-time bandwidth.

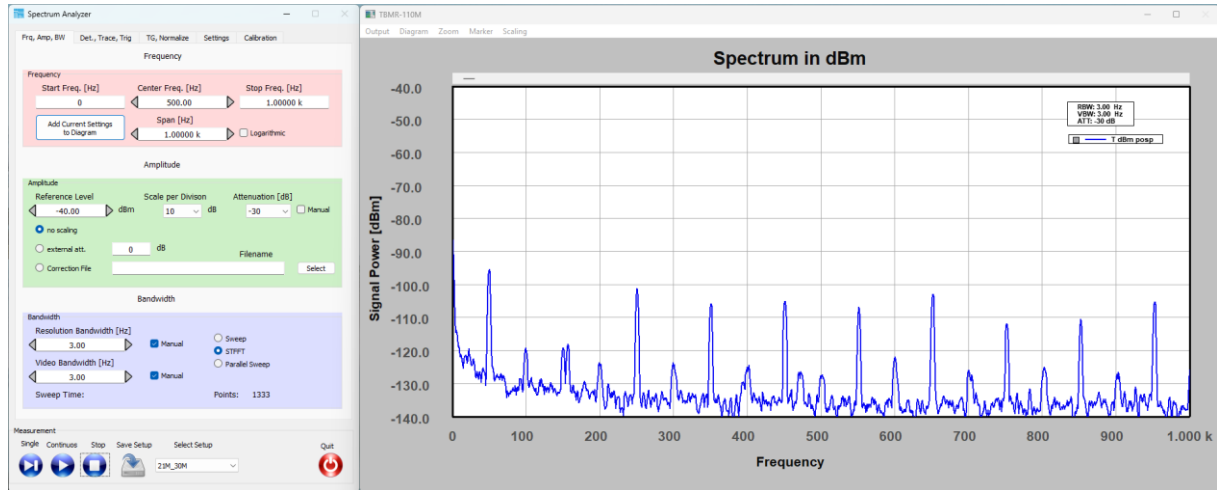

Figure 1-3 Measurement example

The unique ability to measure down to DC is especially helpful, when it comes to investigate mains harmonics, sub harmonics of switched mode regulators, mechanical vibrations or audio equipment.

1.2.3 Tracking Analyzer

Scalar network analyzer, DC to 110 MHz, dynamic gain control

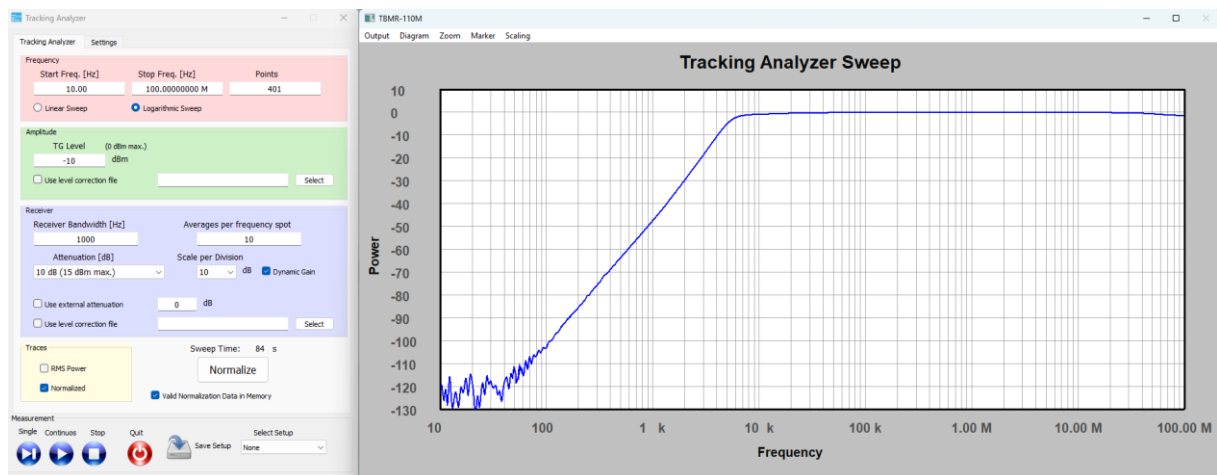

Figure 1-4 Measurement example

Example: Frequency response of the TBHPF1-9kHz high pass filter. The ability to measure down to DC is extremely beneficial when characterizing transducers at very low frequencies. Dynamic gain control allows for a remarkable dynamic range of 110 dB.

1.2.4 Oscilloscope

The oscilloscope is useful, when the noise spectrum of a device such as a switched mode regulator has to be correlated with the time domain.

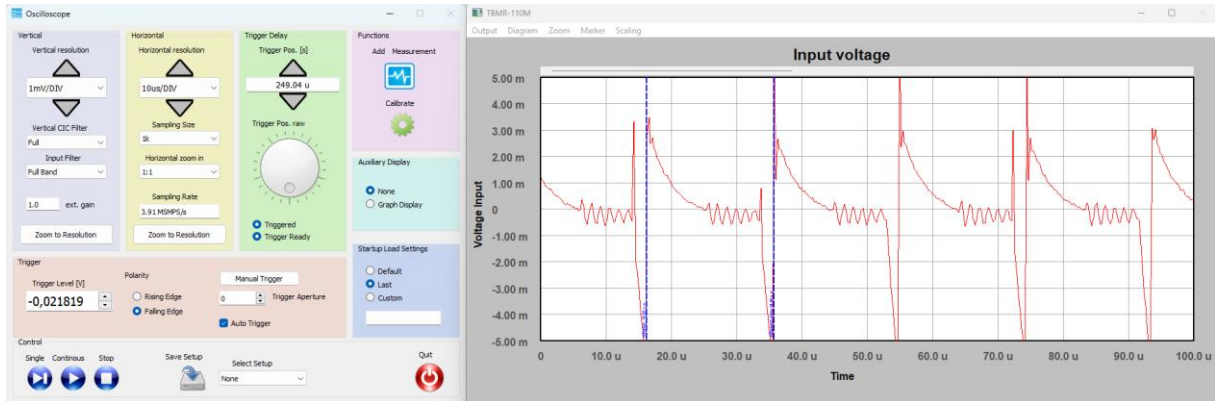

Figure 1-5 Measurement example

1.2.5 Demodulator

The demodulator of the measurement receiver can be used to make interference audible, verify modulation parameters or listen to broadcast stations.

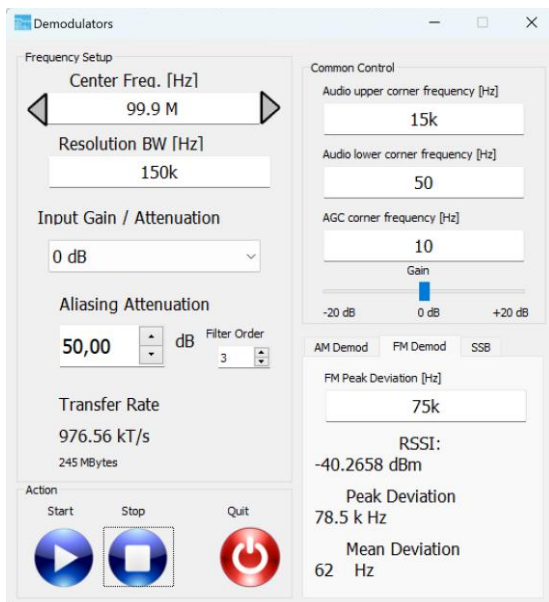

Figure 1-6 Setup example to listen FM broadcast

1.2.6 Remote Control

The remote-control app is used when controlling the receiver with the Tekbox EMCview software. EMCview is an alternative EMI Analyzer software, which has more features than the standard EMI app of the TBMR-110M. However, as EMCview has to communicate with the TBMR-110M software via a UDP channel, measurements are slower than with the standard application of the receiver.

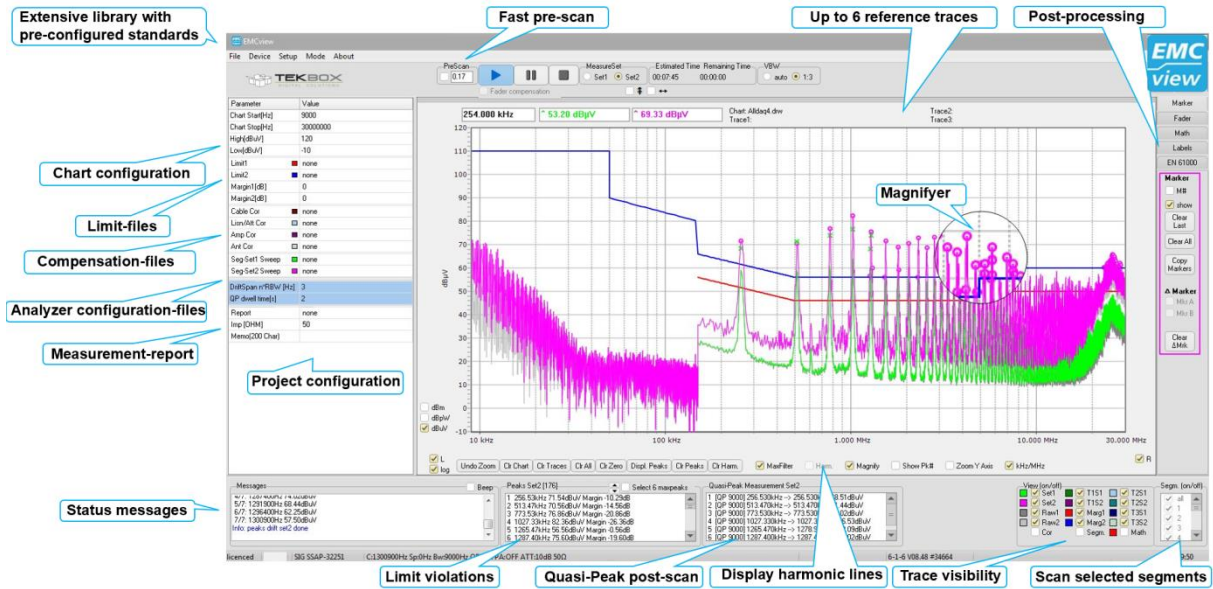

Figure 1-7 Screenshot of EMCview

A customized variant of EMCview is by default supplied together with the TBMR-110M.

1.2.7 Stream I/Q data

This application can be used to stream data to a GNU radio application.

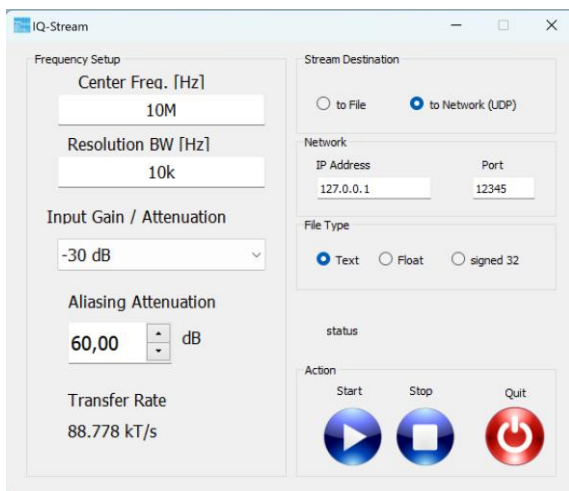

Figure 1-8 I/Q stream generator

1.3 System Requirements

The TBMR-110M system software requires a Microsoft Windows(R) 7 (SP1) 64 Bit, Windows 10 (R), Windows 11 (R) compatible computer with an USB 2.0 high speed interface, about 200 MB free disk space, an Intel Core I5 (R) processor with 3 GHz clock speed (or equivalent) and 4 GB of system memory as minimum recommendation. However, a multi-core processor like Intel i-12000 (R) or better is recommended. The CPU must support AVX2 CPU extension technology. Please note that the software uses heavy multithreading for STFFT and parallel computation. A high- resolution screen of better or equal than 1280x1024 pixels is required, 4k resolution is recommended for more detailed data display.

1.4 Packaging List

When opening the TBMR-110M box please check if following items are included in the package:

- TBMR-110M EMI-analyzer
- USB cable with type A and type B connector
- IEC power cord
- TBFL1 combined attenuator/ high pass filter / limiter
- USB Stick containing the TBMR-110M software, EMCview software and manual
- Quick Start Guide

1.5 Unpacking and Preparations for First Use.



Figure 1-9 TBMR-110M side view

Carefully unpack the shipping box and remove the packaging material. Carefully check your TBMR-110M for any shipping damage.

Check if the receiver's AC mains supply voltage matches the power grid voltage in your country. To do so, turn the analyzer around and have a look at the rear panel.

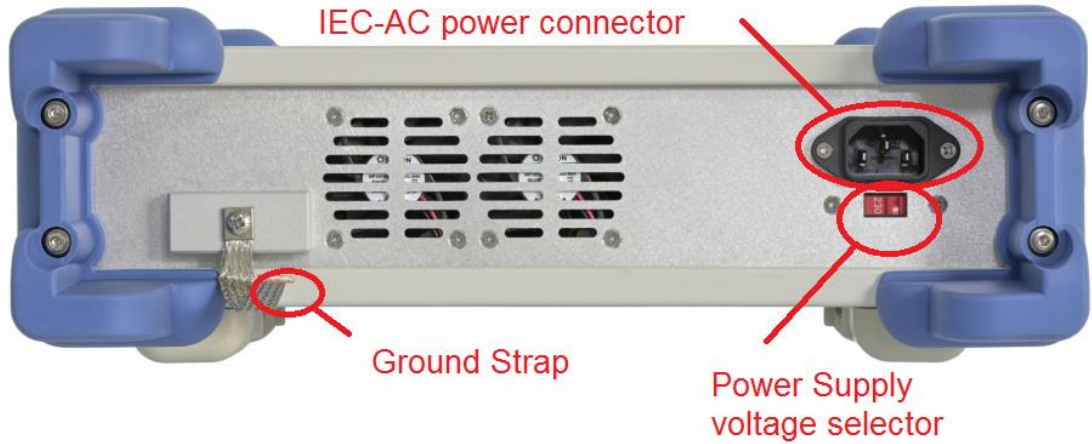

Figure 1-10 TBMR-110M rear view

Check the currently selected AC mains supply voltage on the power supply voltage selector.



Figure 1-11 TBMR-110M mains supply voltage selector

If the displayed voltage DOES NOT match your countries power grid voltage, please move the voltage selector switch in the opposite direction using a fitting tool, e.g. screw-driver.

Possible settings are: **115 VAC and 230 VAC.**

For voltages in the range 100 VAC to 120 VAC use the 115 VAC setting.

For voltages in the range 200 VAC to 240 VAC use the 230 VAC setting.

	<p>Warning: Mains voltage selector</p> <p>Operating the TBMR-110M Analyzer set to the wrong mains supply voltage may damage the equipment.</p>
--	---

Connect the Ground Strap of the receiver to your reference ground plane. This will ensure minimum noise and interference pick-up. Please note that all metal parts of the analyzer are connected to ground internally as well as to the ground wire of the IEC cable.

	Proper grounding is necessary to achieve accurate measurements
---	---



Figure 1-12 IEC cable connector

Use your supplied IEC-power-chord and plug it into the TBMR power inlet on the back of the device. Plug the power cable then into a suitable power plug. Now connect the TBMR-USB port to your PC using the supplied USB cable.



Figure 1-13 supplied USB cable

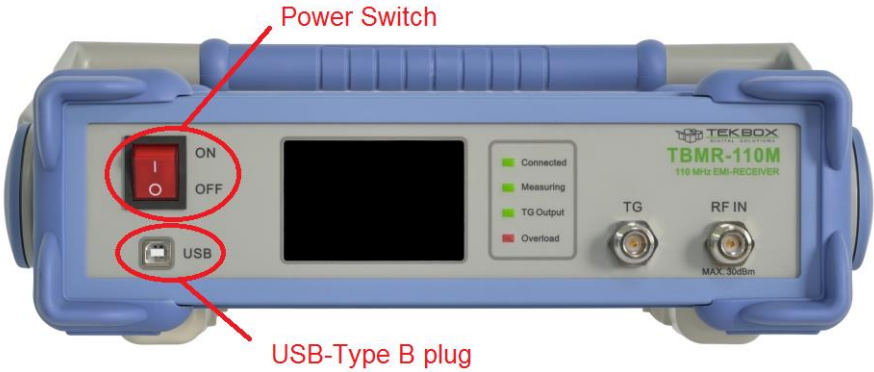

Figure 1-14 TBMR-110M front view

1.6 Software Installation

Plug the supplied USB Stick into the USB port of the PC which you want to connect to the receiver and open the software folder. Start the "Setup_TBMR-110M_Vxxx.exe" file as administrator. The Installer will guide you through the rest of the Installation.



Welcome to TBMR-110M Measurement
Receiver Setup

110 MHz EMI Receiver

Install

Options

Copyright © 2024 TekBox

Figure 1-15 TBMR-110M SW installer window

The Installer will install both the receiver software as well as the device driver.

1.7 First Power - On

After the software has been successfully installed and the PC is linked to the receiver, the device can be powered on. To do so, turn on the power switch shown in Figure 1.6 and look at the receiver's TFT display.

```
-----  
TekBox TBMR-110M EMI Analyzer  
(c) 2020-2024  
FW Revision: 2.1  
-----  
FPGA bus.....OK.  
ADC setup.....OK.  
Config Load .....OK.  
ADC Data.....OK.  
FIFO.....OK.  
-----  
Start USB engine.  
-----  
Waiting on initial USB connect.....  
Connected.
```

Figure 1-16 TBMR-110M auxiliary TFT display

The receiver performs several power-on self-tests (POST) and displays the results on the display. All test shall be OK to perform correct operation. If the USB driver is loaded correctly, the text "Connected" will be displayed on the TFT screen and the green LED "Connected" will light up on the analyzer front panel. The display can also be configured to display the measurement graphs.

In the device manager a new device folder "TekBox" should appear:

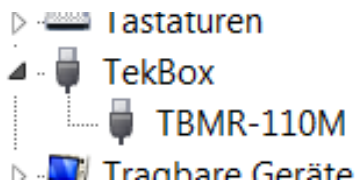

Figure 1-17 Windows Device Manager indicating that the receiver is successfully connected

If the analyzer does not connect successfully to your PC, please verify the USB connection. Turn off the analyzer and turn it back on after 2 seconds to check Windows Status outputs in the right lower corner of the screen.

If everything is correctly installed, you can now invoke the main application by double-clicking the Desktop icon or selecting the application from the program list.

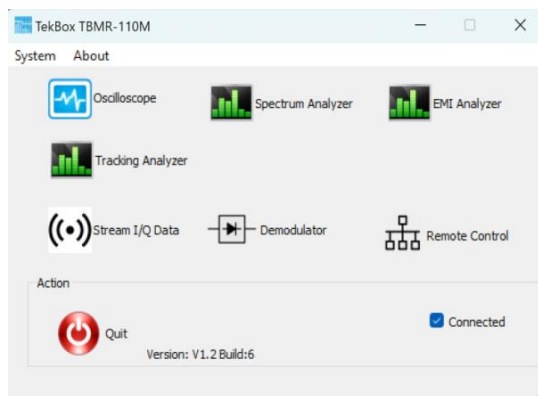

Figure 1-18 Main application window

If the device driver is properly loaded, the "Connected" - box is checked and the receiver is ready for operation.

For a first test, click on the EMI Analyzer icon. Following window will pop up:

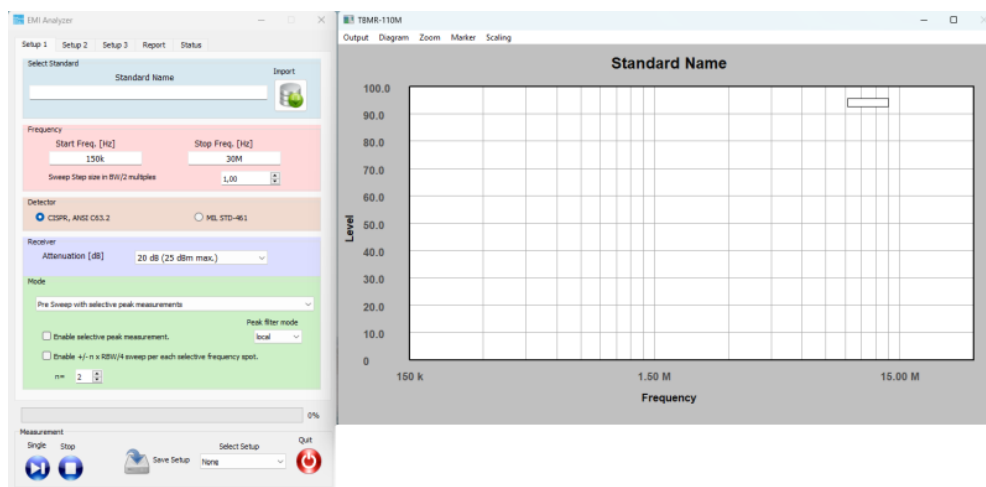

Figure 1-19 Main EMI analyzer window

Now click on the Import Icon on the top of the window and navigate to a project file folder, e.g.:

CISPR 32_EN55032_V1_3\CN

Select a project file, e.g.:

CN_CISPR32_EN55032_CLASS_A_Mains.prj

and press the "Open" button.

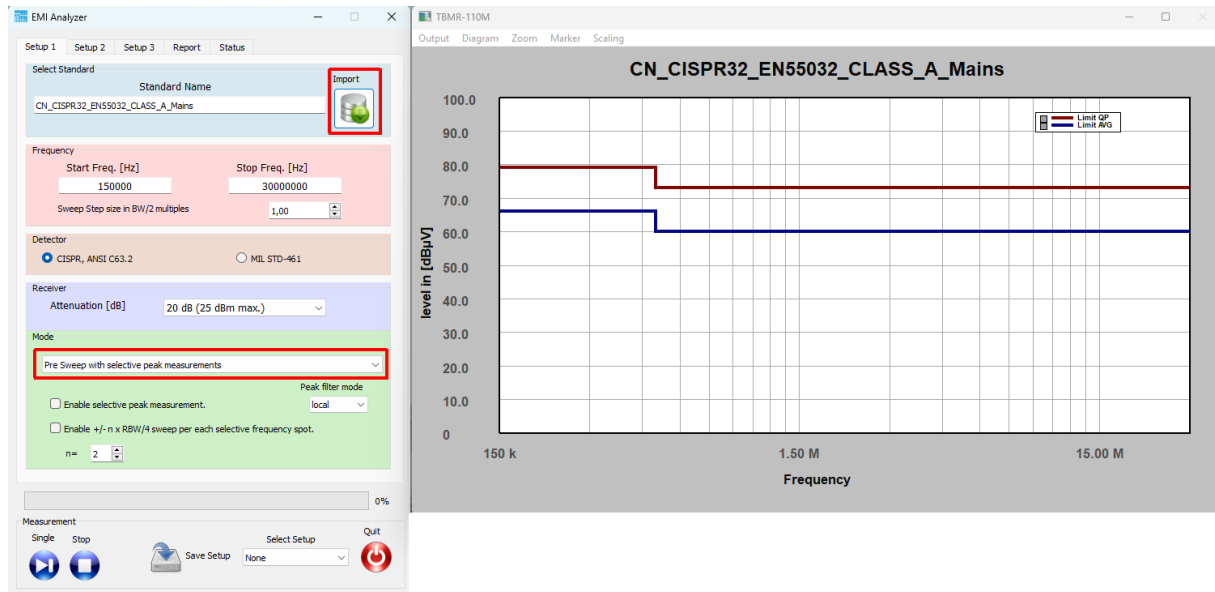

Figure 1-20 EN 55032 project loaded

Next, select Pre FFT Sweep with selective peak measurements.

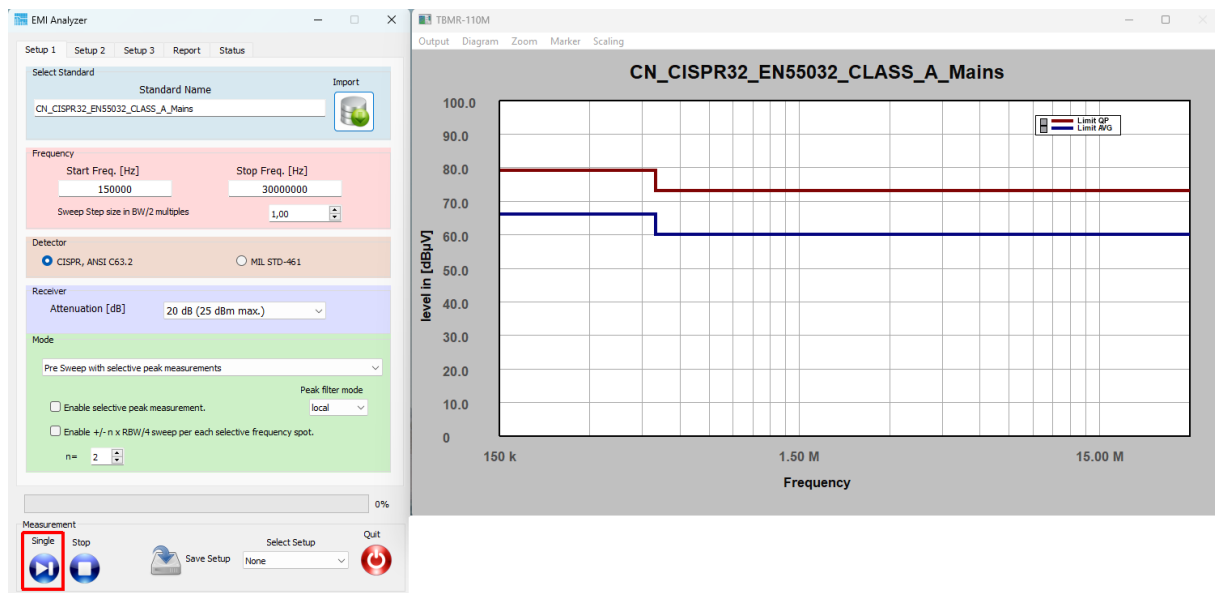

Figure 1-21 Press the "Start Single Measurement" button

Without signal applied, after a few seconds of operation, the diagram window should show a result similar to the figure shown below:

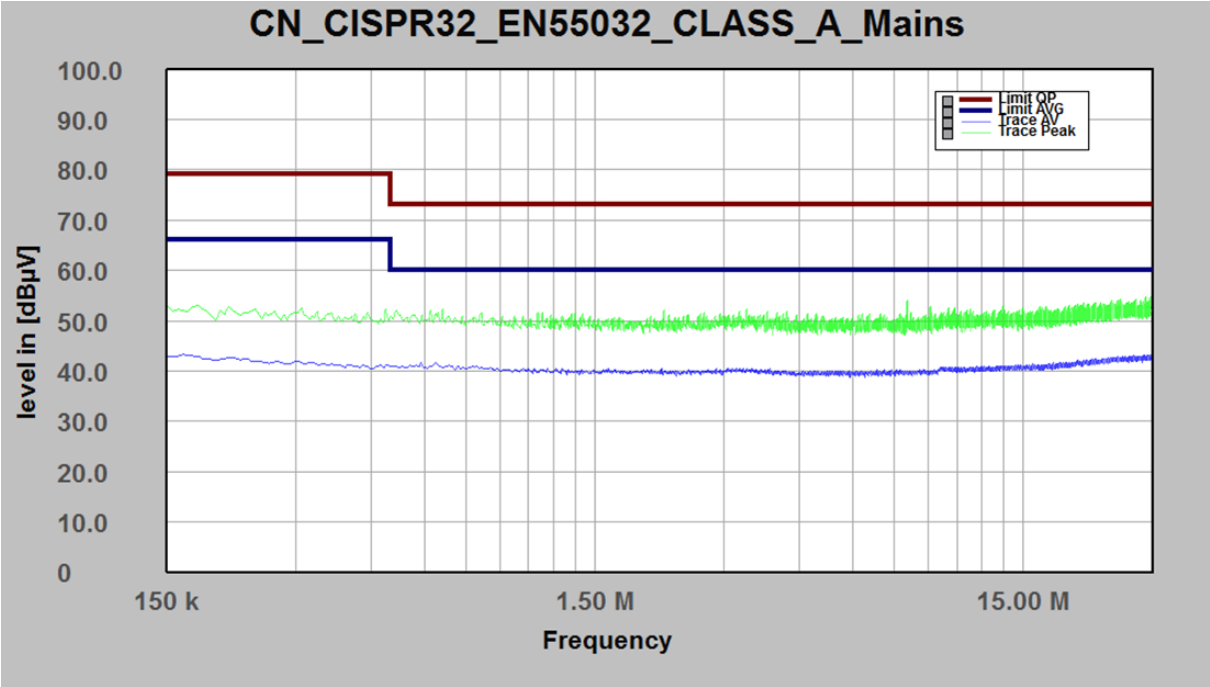

Figure 1-22 Measurement result; no signal connected to the RF-input

Congratulations! You have made your first EMI measurement with the TBMR-110M.

2 Operation

2.1 Front Panel Elements.

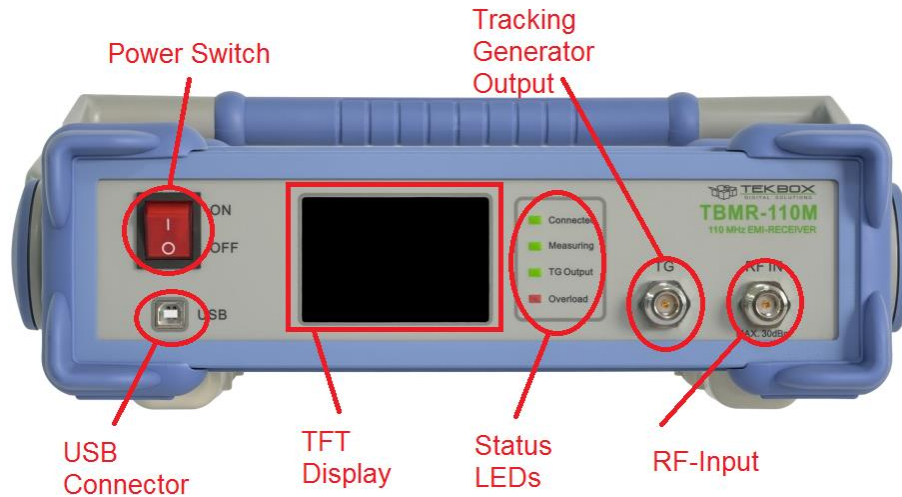

Figure 2-1 Front panel

- Power Switch: Turns the Analyzer on or off
- USB Connector: Connecting the Analyzer to a Computer
- TFT Display: For Status and Data Display
- Status LEDs:
 - Connected: indicates, that the USB connection to the control-PC is established
 - Measuring: indicates an ongoing measurement
 - TG Output: indicates, that the Tracking Generator is enabled
 - Overload: indicates a RF-input overload condition **during** a measurement, accompanied by buzzer sound
- Tracking Generator Output: DC - 100 MHz Tracking Generator Output
- RF-Input: Analyzer RF signal input (maximum rating 30 dBm)

	<p>Warning: Maximum RF input power rating</p> <p>The maximum allowed RF input power is +30 dBm (1 W or 7V) continuous power. However, this value is only achieved, when 30 dB of internal attenuation is selected! For lower internal attenuation or internal gain, the input power must be reduced accordingly! Exceeding +15 dBm can damage the analyzer. Be aware this also holds true for short transients or bursts!</p> <p>An overload condition will be only detected during a running measurement!</p> <p>Exceeding the maximum RF input power or voltage will damage the instrument!</p>
--	---

2.2 Theory of Operation

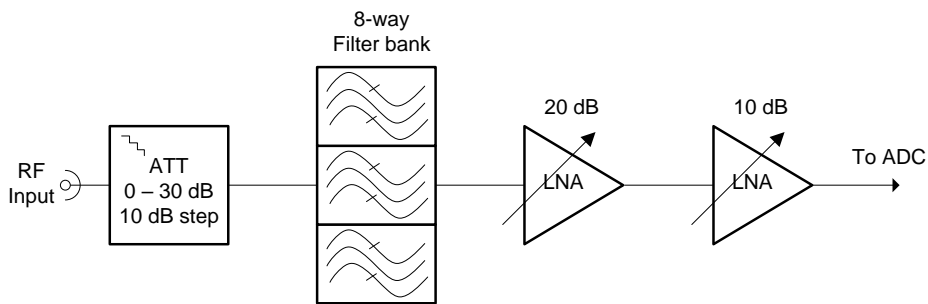

Figure 2-2 RF section block diagram

The RF input is connected to a switchable attenuator with an attenuation range from 0 dB to 30 dB in 10 dB steps and to input protection circuitry. Next comes an 8-path pre-selector with following filter characteristics:

Filter No	Characteristic	Frequency Range
1	Trough	DC - 110 MHz
2	Low pass	DC - 150 kHz
3	Band Pass	150 kHz - 500 kHz
4	Band Pass	500 kHz - 3 MHz
5	Band Pass	3 MHz - 10 MHz
6	Band Pass	10 MHz - 20 MHz
7	Band Pass	20 MHz - 30 MHz
8	Band Pass	30 MHz - 110 MHz

Table 2-1 Pre-selector filter characteristics

The output of the pre-selector feeds two sequential LNAs. The first stage has 20 dB gain and the second stage provides 10 dB gain. This allows a gain adjustment of 0 to 30 dB in 10 dB steps.

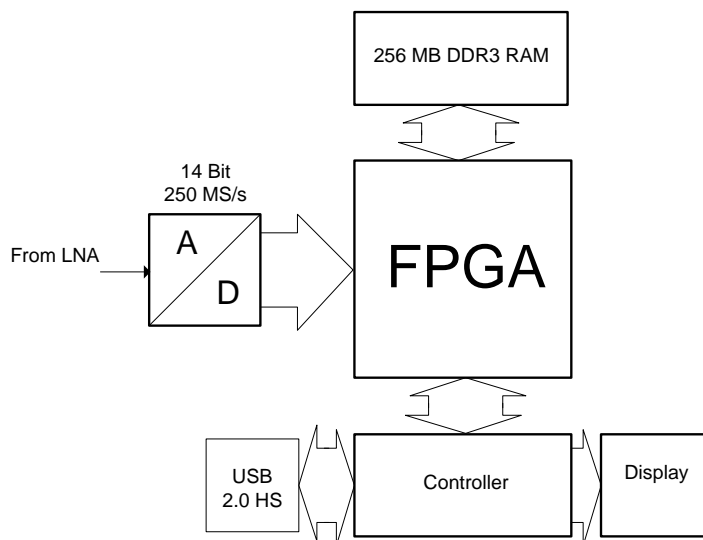

Figure 2-3 Block diagram of the digital section

The RF signal is sampled, A/D converted and then processed in a FPGA (custom logic) block, before storing the data in a fast synchronous 256 MB RAM. The microcontroller reads out the RAM contents and transfers it to the computer via the USB interface where the spectrum is further processed and displayed.

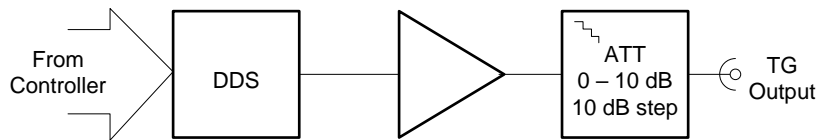

Figure 2-4 Tracking generator block diagram

The tracking generator contains a 250 MHz DDS followed by an amplifier and a switchable 10 dB attenuator. It can produce single tone (CW) signals from very low frequencies up to 100 MHz with maximum output power of 0 dBm.

The Analyzer incorporates a digital receiver with a cascaded switchable and tunable digital filter bank. The maximum RBW is limited to 3.5 MHz. Demodulation, short time-FFT (STFFT) and parallel filtering computation is performed by the computer using heavy multithreading and SIMD (single input multiple data) assembly instructions technology.

- **STFFT (short time FFT)**

A complex FFT is calculated using a window function for maximum side lobe suppression and amplitude accuracy. The FFT is repeated in certain sample distances from the down-converted input data.

- **Parallel Filtering.** The down-conversion and filtering are done in software and in parallel using multiple threads and SIMD assembly instructions. This allows the calculation of several frequency points of a sweep in parallel.

2.3 Starting the Software

The TBMR-110M software can be launched by either double-clicking the desktop icon or by selecting it from the TekBox Program folder. The following window will appear when the software starts:

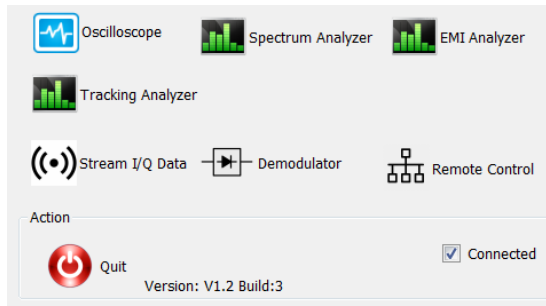

Figure 2-5 Main window, USB connected

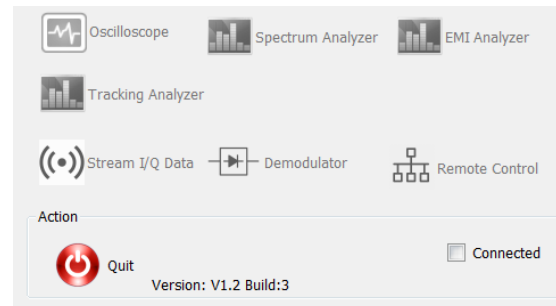

Figure 2-6 Main window, No USB connection

Following command line options are available:

- `-platform windows:dpiawareness=0`
This option allows to scale the GUI in order to display the fonts correctly. Setting this option allows for compensation on font scaling. Use it, if you have an HDR monitor.
- `dark`
This option enables a dark-style GUI display. Please keep in mind that only Windows 10 and Windows 11 will render Windows titles in black.
- `remote`
This option will start the "remote control" application directly and hide the main window.
- `nodebug`
This option will hide the debug text information during remote control operation. Note: option `remote` already disables debug information.

If a TBMR-100M analyzer is detected via USB, the “connected” box will be checked. Otherwise, all application icons will be grayed out and not accessible.

The Quit button will terminate the application.

Besides the applications, the main window contains two menu items:

System menu

The **System** Menu contains following sub items:

- **Select Home Path**
This item let you select a different home path folder for data and setup storage. Default is: `<UserProfile>/TekBox/TBMR-110M`
- **System Test**
This item will perform several hardware tests and display version information. An unchecked test checkbox will indicate a hardware malfunction.

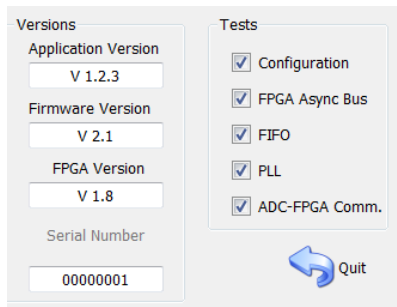

Figure 2-7 System menu

- System Service

This item will only be accessible after entering a valid password. It allows to update the microcontroller Firmware and FPGA Firmware of the analyzer. This is explained in detail in the FW update chapter

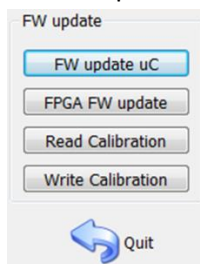

Figure 2-8 Service menu

- Read Calibration

Saves the analyzer's calibration data to the computer

- Write calibration

Loads a calibration file from the computer and stores it on the analyzer. Needs an analyzer power cycle to be activated.

Unlock Calibration

Entering the password will unlock the calibration functionality and enable the System Service item. The default password is a zero-string, which means just press <Enter>.

- Change Password

This menu item will allow you to alter the calibration password.

	The default password upon delivery is a zero-length string, so simply press <Enter>
--	--

About menu

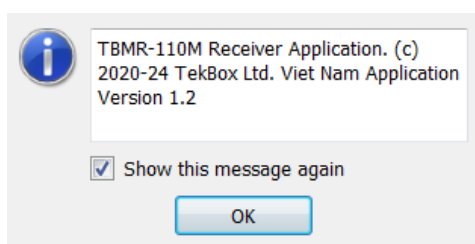

Figure 2-9 About menu, displaying the application software version

2.4 EMI Analyzer Application

Setup 1 Tab

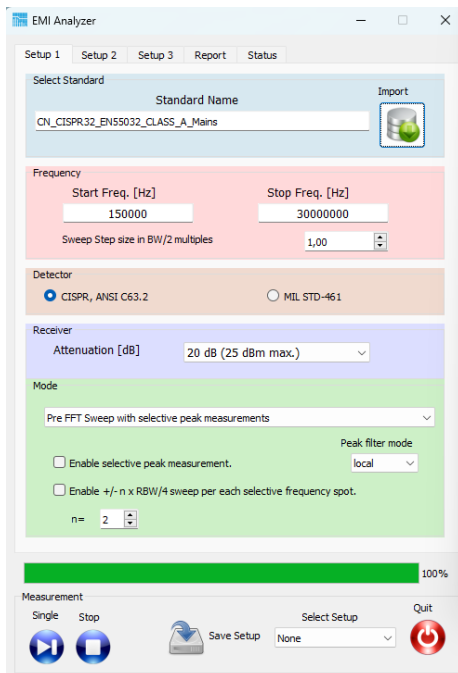

Figure 2-10 EMI Analyzer window; Setup 1 Tab, EN 55032 project loaded from the list of pre-configured projects

The EMI Analyzer GUI has been arranged in a top to down workflow structure.

EMC measurements can be configured manually, however all conducted emission tests of major standards are already implemented.

First load a suitable EMI Project from a pre-defined list. The projects are sorted in EMI standard sub-directories and contain all relevant emission limits. The standards are implemented as text files, very similar to the EMCview project file standard. Consult the EMCview manual on more details about the project files.

Upon loading a project file, the measurement frequency range will be loaded automatically. Following CISPR 16, the spacing of two adjacent frequency points (sweep step size) is predefined to $RBW/2$. A value between 0.0 and 1.0 would increase the measurement resolution while a value > 1.0 would reduce it.

	<p>CISPR 16: Two adjacent frequency points shall not be spaced more than half of the resolution bandwidth. A sweep step size > 1 will create gaps in the spectrum and results may appear to low in amplitude and shifted in frequency</p>
--	--

Detector settings are specified in the pre-configured project files and can be selected according to CISPR 16-1-1, ANSI C63.2 or MIL Std-461, DO-160.

The implemented detectors emulate the hardware description of the corresponding standard as closely as possible. This is in reference to the rise and fall times of the Quasi-peak detector, as well the meter constant. The EMI Analyzer Software will select the correct resolution bandwidth and detector constants automatically during measurement.

CISPR Band	A	B	C
Frequency Range	9 kHz - 150 kHz	150 kHz - 30 MHz	30 MHz - 110 MHz
-6 dB Bandwidth	200 Hz	9 kHz	120 kHz
QP charge time	45 ms	1 ms	1 ms
QP discharge time	500 ms	160 ms	100 ms
Meter constant	160 ms	160 ms	100 ms

Table 2-2 CISPR and ANSI detector parameters

Frequency Range	- 6dB Bandwidth
30 Hz - 1000 Hz	10 Hz
1 kHz - 10 kHz	100 Hz
10 kHz - 150 kHz	1 kHz
150 kHz - 10 MHz	10 kHz
10 MHz - 30 MHz	10 kHz
30 MHz - 1 GHz	100 kHz

Table 2-3 MIL-STD-461 and DO-160 detector parameters

The next section sets the input attenuator or amplifier. Maximum linear input power rating for the selected attenuation / gain is always given in brackets:

Attenuation [dB]	Absolute Max. Input Level [dBm, dB μ V, V]
30	30 dBm, 137 dB μ V, 7 V
20	30 dBm, 137 dB μ V, 7 V
10	25 dBm, 132 dB μ V, 4 V
0	15 dBm, 122 dB μ V, 1.25 V
-10 (equivalent 10dB gain)	15 dBm, 122 dB μ V, 1.25 V
-20 (equivalent 20dB gain)	15 dBm, 122 dB μ V, 1.25 V
-30 (equivalent 30dB gain)	15 dBm, 122 dB μ V, 1.25 V

Table 2-4 Absolute Maximum RF input power and corresponding attenuator / gain settings, exceeding these levels will cause permanent damage to the analyzer

Always use an external attenuator/limiter, if you test an unknown EUT / source. Levels above the given input power / voltage rating (even for short bursts) will trigger an overload condition only during an active measurement.

	<p>Warning: Maximum RF input power handling The maximum allowed RF input power is +30 dBm (1 W or 7V) continuous power. However, this value is only allowed when 30 dB of internal attenuation is selected! For lower internal attenuation or internal gain, the input power must be reduced accordingly! Exceeding the maximum RF input power or voltage will damage the instrument!</p>
---	---

Upon starting the EMI Analyzer, the receiver attenuation is set to 20 dB. Once you've confirmed that there are no signals with excessive amplitude, you may want to reduce attenuation or increase gain to achieve adequate dynamic range. For a CISPR-compliant measurement, the base noise floor must be at least 6 dB lower than the limit line's lowest level.

Following measurement methods can be selected:

- **Pre Sweep with selective peak measurements**
This method uses frequency stepping of a digital heterodyne receiver, where a first, faster sweep is made using Peak and Average or RMS detector. Thereafter, each limit violation will be re-measured using standard compliant Quasi-Peak and CISPR-Average detectors. The receiver measures like a classic swept receiver, one frequency point after another.
- **Pre parallel Sweep with selective peak measurements**
Similar to the method above, this implementation uses frequency stepping of a digital heterodyne receiver, where a first, faster sweep is made using Peak and Average or RMS detector. Thereafter, each limit violation will be re-measured using standard compliant Quasi-Peak and CISPR-Average detectors. In contrary to the method above, the pre-sweep is made using software parallel filters and detectors and consequently will be considerable faster. The resulting speed depends on how many parallel cores are available in the CPU of the involved PC.
- **Pre FFT Sweep with selective peak measurements**
This is another measurement method, where a first faster sweep is made with Peak and Average or RMS detector. Thereafter, each limit violation will be re-measured using standard compliant Quasi-Peak and CISPR-Average detectors. The pre-sweep is fast, using software STFFT and parallel detectors.
- **Direct parallel full compliance measurement**
This measurement method will directly measure with Quasi-Peak and CISPR-Average detectors and uses software parallel filters and detectors. It is faster than the classic approach
- **Direct FFT full compliance measurement**
This option will also directly measure with Quasi-Peak and CISPR-Average detectors and uses software STFFT filters and detectors. It is the fastest compliance option.

The checkbox "Enable selective peak measurements" will enable peak re-measurement for the first three options above. If left unchecked only a pre-sweep is performed.

The Checkbox " Enable +/- n x RBW/4 sweep per each selective frequency spot." will do a local frequency sweep around each detected peak. This is especially useful for measurements on devices which may change their EMI frequency spectrum e.g. during warm up. This peak-search will ensure that the highest peak will be detected in a window of n x RBW/4. The factor n can be adjusted.

Peak filter mode:

- **none**
No peak filter technique is used, every violation of the peak threshold is re-measured for each point of the current sweep.
- **local**
Each local peak will be re-measured.
- **max**
A peak must violate the threshold and then drop below the threshold again to consider it a peak for re-measurement.

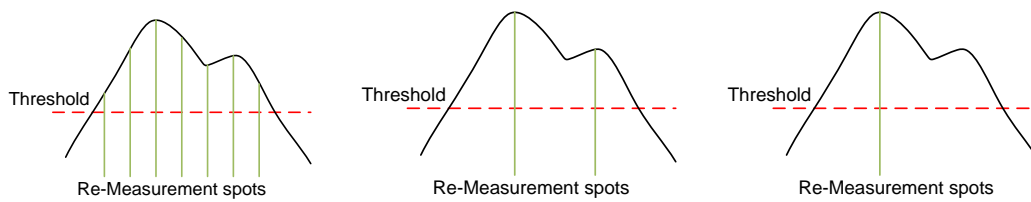

Figure 2-11 Peak filter mode: none, local, max (from left to right)

Setup 2 Tab

In the Setup 2 tab, sweep parameters and compensation files are configured

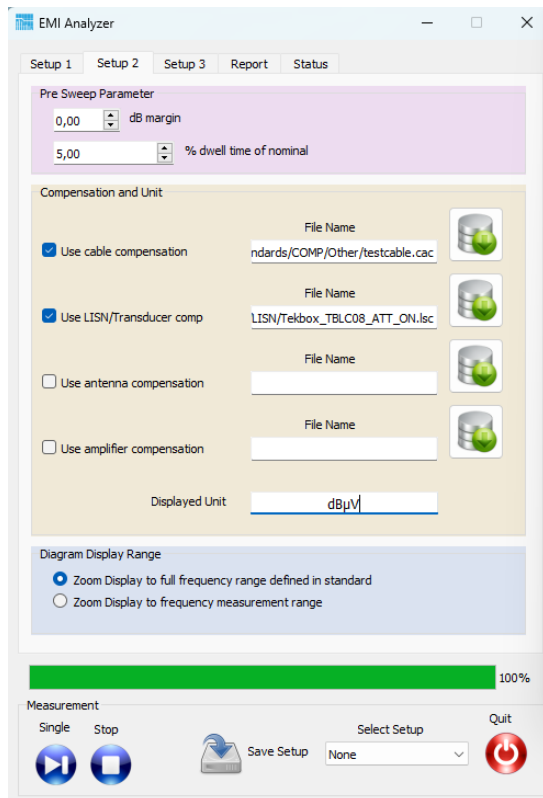

Figure 2-12 EMI Analyzer window; Setup 2 Tab, compensation files automatically loaded when importing a project

Pre Sweep parameters:

- **dB margin:**
Sets the threshold for peak detection from the given standard limits. Each measured value above the threshold is potentially re-measured using compliance detectors.
- **% dwell time of nominal:**
The default measurement speed of the pre-sweep is faster than the nominal compliant measurement time. This value sets the measurement time in percent of the nominal time. Increasing the time increases the chance to capture sporadic EMI events for EUTs, which perform many different tasks. When testing switched mode regulators which are not subject to sporadic load changes, there is no necessity to use a long dwell time.



**A short dwell time can result in missing peaks.
A long dwell time results in long measurement time.**

Compensation settings:

Compensation files correct for the frequency response of components of the EMC test setup. These are typically cables, transducers such as LISN, RF current monitoring probes, attenuators or amplifiers.

Certain compensation files also carry out unit conversions, such as transimpedance files of RF current monitoring probes, which convert the voltage at the probe output into the current flowing through the aperture or antenna factor files, which convert the antenna voltage into electrical or magnetic field-strength.

Compensation files are self-explaining text files. As an example, an attenuator file would contain frequency points with the corresponding attenuation at this frequency. LISN files contain frequency points with the voltage division ratio value of the corresponding frequency. Any frequency points in between will be interpolated.

The compensation implements following equation:

$$\text{Displayed_Value} = \text{Measured_Value} - \text{Cable_Comp} - \text{LISN/Trans_Comp} + \text{Antenna_Comp} - \text{Amplifier_Comp}$$

With all values to be in the logarithmic domain (dB).

The compensation file format follows the syntax as described in Appendix -> Correction File Format.

The displayed unit does not to be configured manually. It is specified in the limit files of the standard. The TBMR-110M software automatically loads suitable compensation files, when loading a project. Compensation files for most Tekbox transducers and for a few third-party transducers are already pre-installed. Tekbox typically releases compensation files for new products on the product websites. These can be downloaded and copied into the compensation file folders of the TBMR-110M software.

Setup 3 Tab

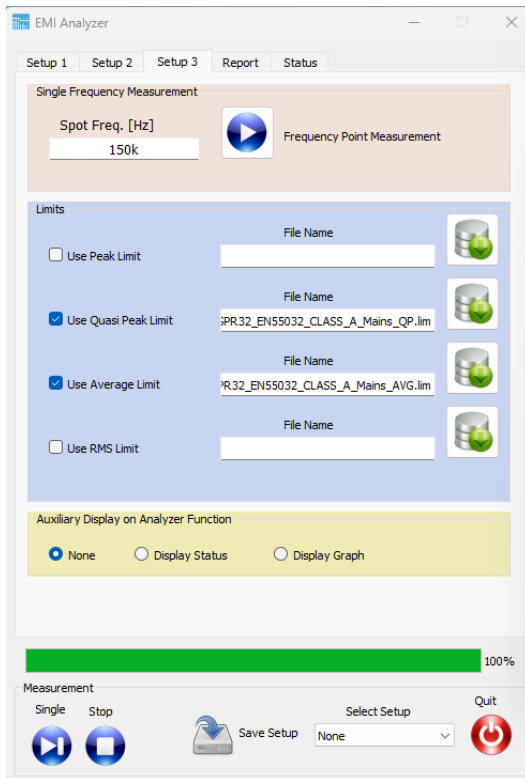

Figure 2-13 EMI Analyzer window; Setup 3 Tab; limit files of the selected project automatically loaded

Setup Tab 3 top does allow for single frequency spot measurement. If some peak seems suspicious or another Tab not covered frequency band is of interest this is a convenient way to measure a single frequency location. Just enter the desired frequency value and press the "Play" button. Another window will pop up and continuously measure and update the result according to the selected standard.

Freq:	150.00 kHz			
RBW:	9.000 kHz			
Dwell Time:	1000 ms			
	Value	Limit	Margin	
RMS:	43.9 dB μ V	n.a.	n.a.	
Peak:	53.9 dB μ V	n.a.	n.a.	
Average:	42.8 dB μ V	66.0 dB μ V	23.2 dB	
QP:	48.8 dB μ V	79.0 dB μ V	30.2 dB	

Figure 2-14 Example; spot measurement according to EN 55032 Class A

Moreover, the Setup 3 tab contains the limit files of the imported standard. The files are loaded automatically when a project file is imported. Furthermore, it is possible to independently load different or customized limit lines for each detector. Detectors are specified in the limit files. Measurement results are only displayed when limit files are present.

In the Setup 3 tab, you can configure the use of the auxiliary TFT display at the front panel of the receiver. It can be set to display nothing except the boot screen, display status messages during measurements or to display the measurement graph.

Report Tab

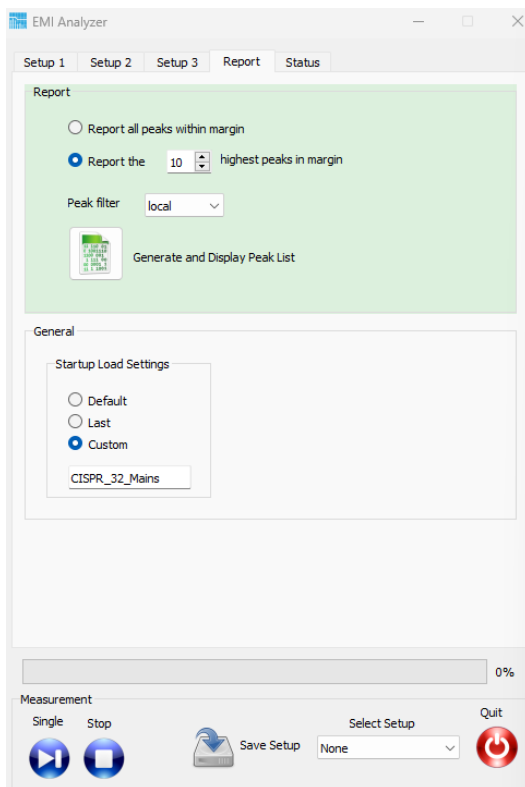

Figure 2-15 EMI Analyzer window; Report Tab

In the report tab, a CSV file with a peak report can be configured and exported. Run the receiver remotely with EMCview, if you want to create more detailed reports.

Furthermore, you can configure the appearance of the EMI analyzer after startup. When using any TBMR-110M application, it is recommended to arrange the app window and graph window according to personal preference and configure the “Startup Load Settings” to “Last”.

- **“Default” Startup:**
The application window will pop up in the center of the display. The graph window can be attached to the application window, by pressing the “CTRL” button, while shifting it with the mouse. With the next start of the app, the relative position of the graph window with respect to the app window will be restored.
- **“Last” Startup:**
Restarts the application with the settings from the previous session.
- **“Custom” Startup:**
Restarts the application using a custom configuration. The setup must be found among the saved setups. The name of the setup must be entered manually.

Status Tab

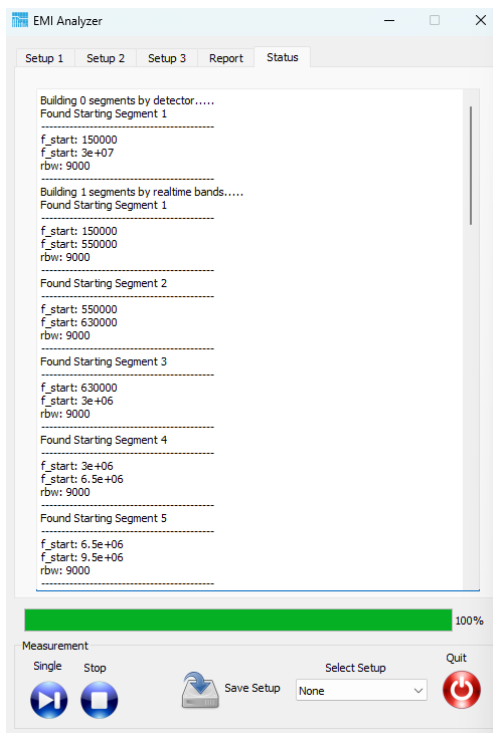

Figure 2-16 EMI Analyzer window; Status Tab

The status tab window displays status messages that were created during measurement. It can be used for debugging purposes.

2.5 Spectrum Analyzer Application

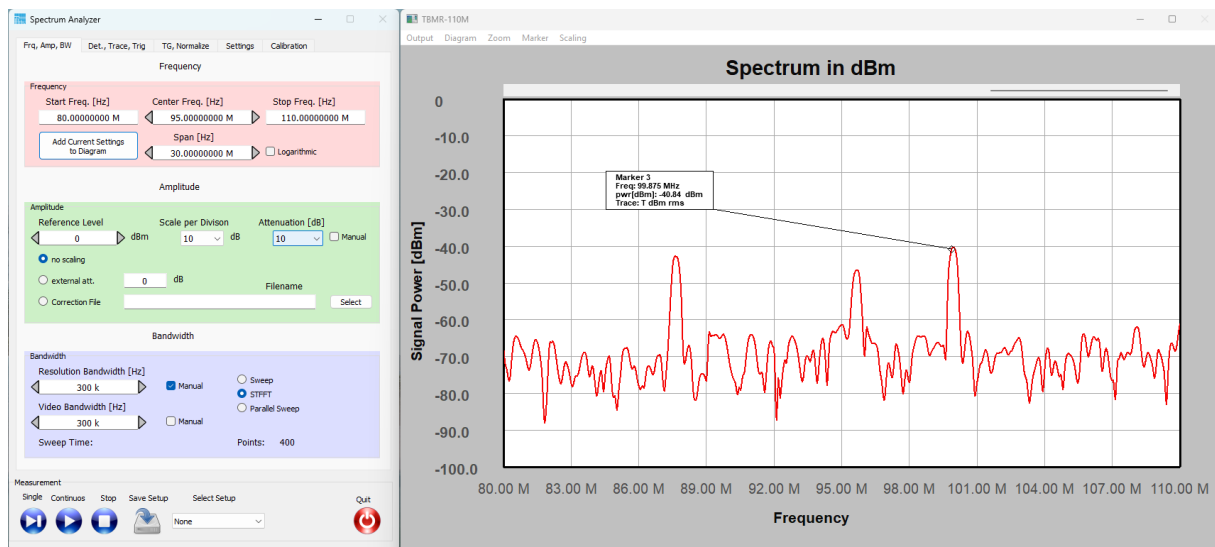

Figure 2-17 Example; screen shot of the spectrum analyzer application

The spectrum analyzer application has essentially the same functionality as most traditional spectrum analyzers. However, it is unique in its measurement capability at low frequencies.

Frequency / Amplitude / Resolution Bandwidth Tab

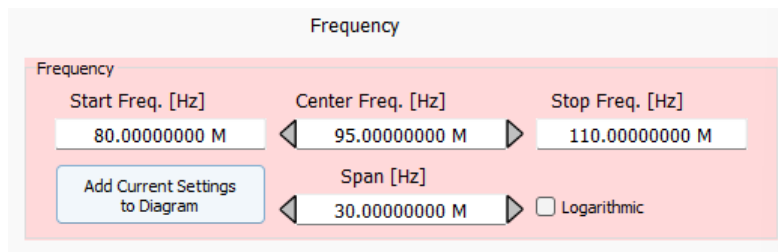

Figure 2-18 Frequency menu

When modifying Start- and Stop - Frequency settings, ensure that the entered value of the start frequency is lower than the stop frequency or vice versa.

By default, the frequency axis is linear. Use the “Logarithmic” checkbox to change to a logarithmic frequency axis. Please note that the display will change to a logarithmic scaling but the frequency sweep will maintain equidistant frequency steps. This leads to a lower step resolution at lower frequencies.

The button “Add Current Settings to Diagram” will add a label containing the RBW, VBW and Attenuation settings to the diagram.

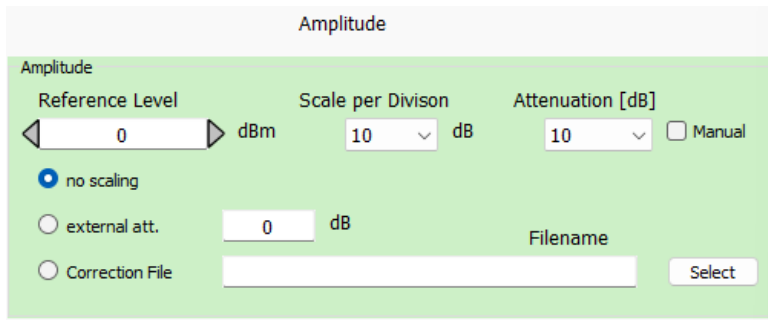

Figure 2-19 Amplitude menu

When adjusting the Reference Level, it is best to leave the "Manual" checkbox unchecked. The attenuation will be automatically matched to the reference level. Be mindful of how the Attenuation / Gain settings affects the TBMR-110M's maximum RF input power rating. Scaling is utilized for compensating, when employing external attenuators or transducers.

Maximum linear input power rating versus attenuation / gain settings:

Attenuation [dB]	Max. Input Level [dBm, dB μ V, V]
30	30 dBm, 137 dBuV, 7 V
20	25 dBm, 132 dBuV, 2.2 V
10	15 dBm, 122 dBuV, 0.7 V
0	5 dBm, 112 dBuV, 0.22 V
-10 (equivalent 10dB gain)	-5 dBm, 102 dBuV, 0.07 V
-20 (equivalent 20dB gain)	-15 dBm, 92 dBuV, 0.02 V
-30 (equivalent 30dB gain)	-25 dBm, 82 dBuV, 0.007 V

Table 2-5 Maximum RF input power and corresponding attenuator / gain settings

Always use an external attenuator/limiter, if you test an unknown EUT / source. Levels above the given input power / voltage rating (even for short bursts) will trigger an overload condition only during an active measurement.

	<p>Warning: Maximum RF input power rating</p> <p>The maximum allowed RF input power is +30 dBm (1 W or 7V) continuous power. However, this value is only achieved, when 30 dB of internal attenuation is selected! For lower internal attenuation or internal gain, the input power must be reduced accordingly! Exceeding the maximum RF input power or voltage will damage the instrument!</p>
---	--

Attenuation [dB]	Absolute Max. Input Level [dBm, dB μ V, V]
30	30 dBm, 137 dBuV, 7 V
20	30 dBm, 137 dBuV, 7 V
10	25 dBm, 132 dBuV, 4 V
0	15 dBm, 122 dBuV, 1.25 V
-10 (equivalent 10dB gain)	15 dBm, 122 dBuV, 1.25 V
-20 (equivalent 20dB gain)	15 dBm, 122 dBuV, 1.25 V
-30 (equivalent 30dB gain)	15 dBm, 122 dBuV, 1.25 V

Table 2-6 Absolute Maximum RF input power and corresponding attenuator / gain settings, exceeding these levels will cause permanent damage to the analyzer.

Amplitude offset / correction

- **No scaling:**
The graph displays the exact amplitude measured at the RF-Input of the TBMR-110M
- **External attenuation:**
Enter the attenuation value, when using an external attenuator
- **Correction file:**
When using a combined attenuator / filter / limiter such as the TBFL1, load the corresponding compensation file

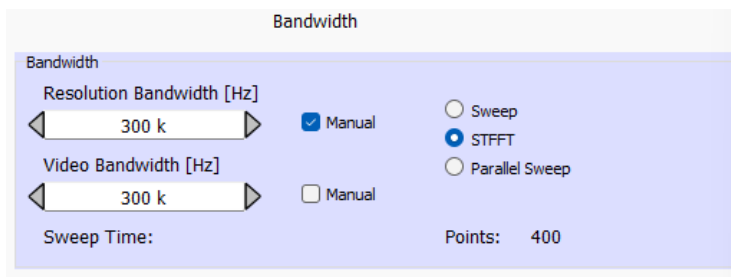

Figure 2-20 Bandwidth menu

The Resolution Bandwidth refers to Gaussian filters specified over their 3dB bandwidth. When manually decreasing resolution bandwidth, the number of measured frequency-points each sweep increases in order to avoid spectrum gaps between adjacent frequency-points. The number of frequency points per sweep is displayed in the lower right corner of the bandwidth menu.

The number of points approaches an unfeasible figure for a certain resolution bandwidth, at which time additional RBW reduction is prevented.

For further RBW reduction, it is recommended to reduce the frequency span.

Detector / Trace / Trigger Tab

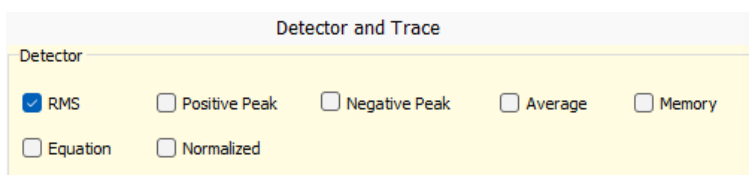

Figure 2-21 Detector and Trace menu

- **RMS, Positive Peak, Negative Peak, Average**
All detectors are available in parallel. A separate trace for each detector will be added to the graph window automatically.
- **Equation**
A trace-arithmetic feature, which can be used to convert the measurement values into other units or to carry out calculations. The syntax for the Equation is described in the Annex.

- **Memory**
Displays a trace, which was stored in memory. In contrary to traces, which are stored using features of the graph window, the Memory-trace can also be used for normalization.
- **Normalized**
Normalizes a trace against the trace stored in memory. This feature can be used to display the difference between two traces, e.g. when investigating the effect of modifications.

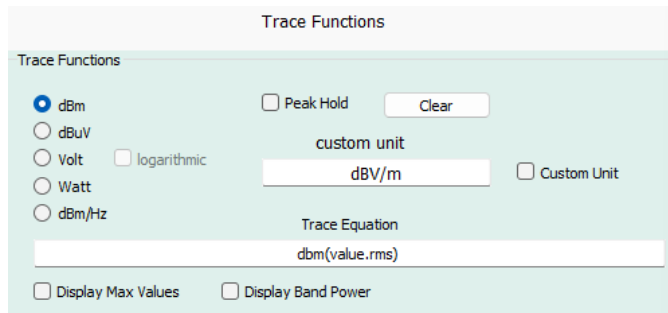

Figure 2-22 Trace functions menu

Check the “Custom Unit” box to select units which are not listed in the left column of the window. To display special results, such as for example $\text{dB}\mu\text{W}/\text{Hz}$ or $\text{nV}/\sqrt{\text{Hz}}$, use an equation for trace arithmetic.

- **Logarithmic**
Changes the amplitude axis between linear and logarithmic
- **Peak (Max) Hold**
Useful for continuous swept frequency measurements where it shows the history of peak values across the frequency axis. Peak Hold shows the maximum level the signal reaches. It is also useful for finding infrequent spurious.
- **Display Max values**
Adds a text box to the graph window, which displays the maximum peak, RMS and Average values of the highest peak within the swept frequency span.
- **Display Band power**
Adds a text box to the graph window, which displays the RMS power integrated over the swept frequency span.

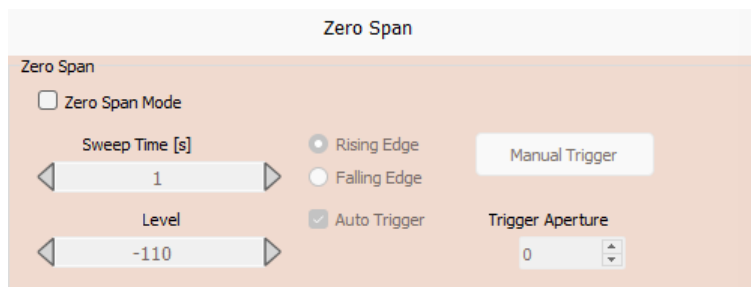

Figure 2-23 Trace functions menu

When set to Zero Span Mode, the analyzer displays the signal at the centre frequency in time domain mode. Sweep time and Trigger settings can be configured.

Tracking Generator / Normalize Tab

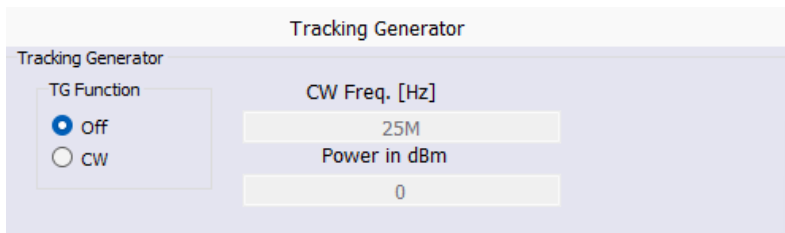

Figure 2-24 Tracking Generator Menu

The tracking generator produces a single tone at the specified frequency when the CW checkbox is enabled. Note that the tracking generator output power cannot achieve 0 dBm at frequencies > 100 MHz. If you require a consistent output power across all frequencies, lower the level to between -5 and -10 dBm.

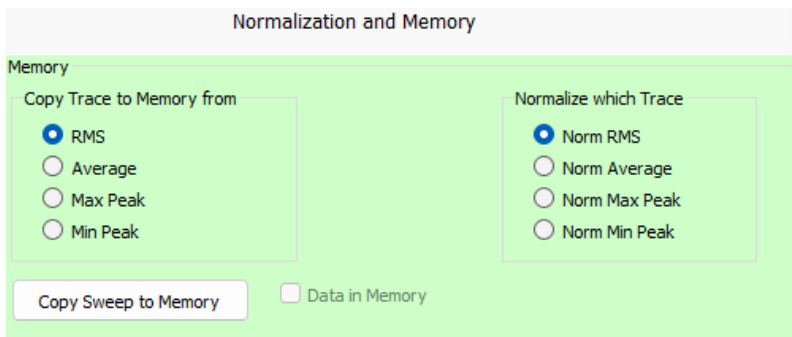

Figure 2-25 Normalization / Memory Menu

To use the Normalization feature, copy the reference trace to memory. Normalization can be used to display the difference between two traces, for example, when investigating the impact of modifications.



Figure 2-26 Limits Menu

This feature opens an editor to create limit lines.

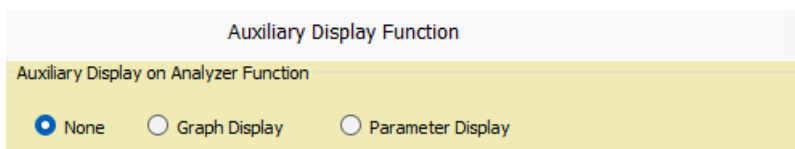

Figure 2-27 Auxiliary Display Menu

Configure the use of the auxiliary TFT display at the front panel of the receiver. It can be set to display nothing except the boot screen, display the measurement graph or display the configured parameters of the spectrum analyzer.

Settings Tab

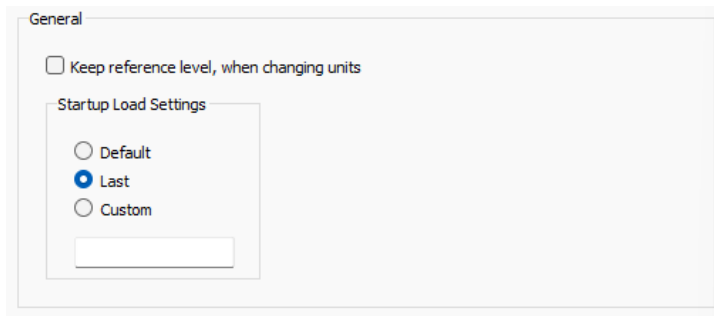

Figure 2-28 Settings Menu

Configure the appearance of the spectrum analyzer after startup. When using any TBMR-110M application, it is recommended to arrange the app window and graph window according to personal preference and configure the “Startup Load Settings” to “Last”.

- **“Default” Startup:**
The application window will pop up in the center of the display. The graph window can be attached to the application window, by pressing the “CTRL” button, while shifting it with the mouse. With the next start of the app, the relative position of the graph window with respect to the app window will be restored.
- **“Last” Startup:**
Restarts the application with the settings from the previous session.
- **“Custom” Startup:**
Restarts the application using a custom configuration. The setup must be found among the saved setups. The name of the setup must be entered manually.

Calibration Tab



The calibration tab is utilized for factory calibration or periodic re-calibration of the receiver. It requires a GPIB to USB converter in order to control a NIST-calibrated RF signal generator to calibrate the analyzer and a NIST-calibrated spectrum analyzer to calibrate the tracking generator. A separate calibration instruction is available upon request from Tekbox.

Figure 2-29 Settings Menu

2.6 Tracking Analyzer Application

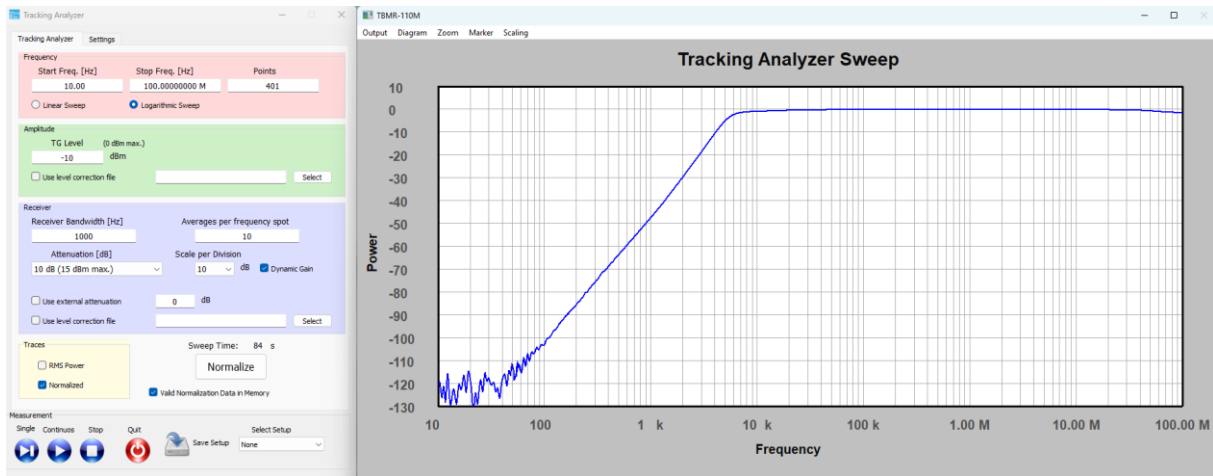

Figure 2-30 Scalar network analyzer, DC to 110 MHz, dynamic gain control; example: frequency response of a high-pass filter

Application: Characterizing the frequency response of transducers from very low frequencies up to 110 MHz.

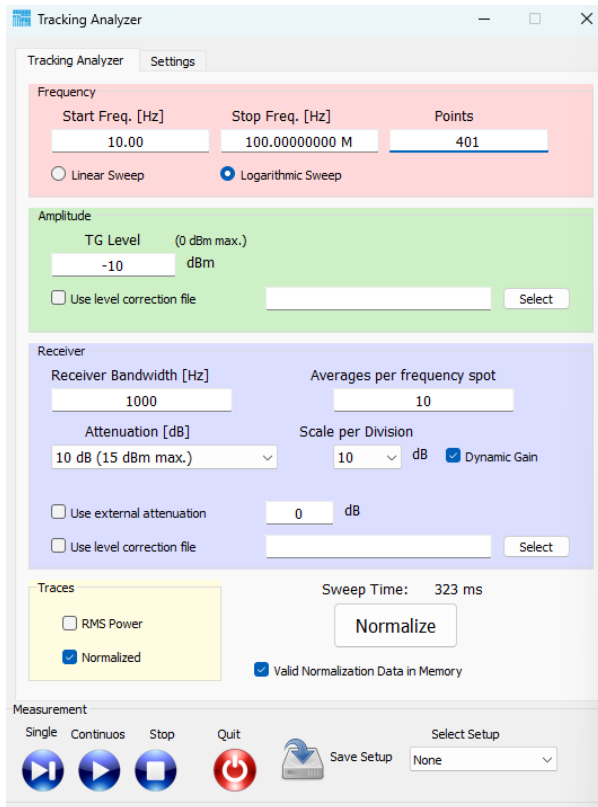

Figure 2-31 Tracking analyzer tab

The implementation of the tracking analyzer is similar to most conventional spectrum analyzers with tracking generator. A coaxial cable connects the tracking generator output with the RF input of the TBMR-110 M for normalization. After normalization, a transducer or other EUT is connected in between tracking generator output and RF-input to measure the frequency response.

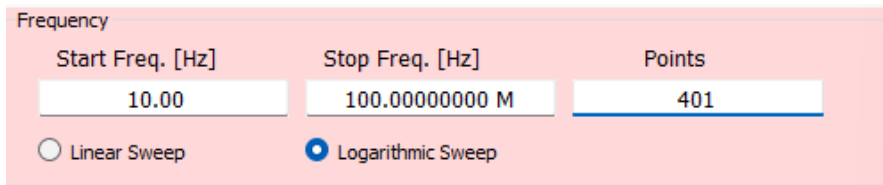

Figure 2-32 Sweep Menu

Enter start and stop frequency of the measurement range and select between linear or logarithmic sweep.

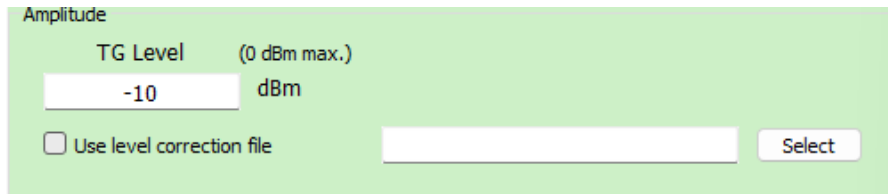

Figure 2-33 Amplitude Menu

If an amplifier is placed in the measurement path to increase the tracking generator signal, a level correction file can be utilized to compensate. To maximize dynamic range while measuring passive devices, set the tracking generator level to between -10 dBm and 0 dBm.

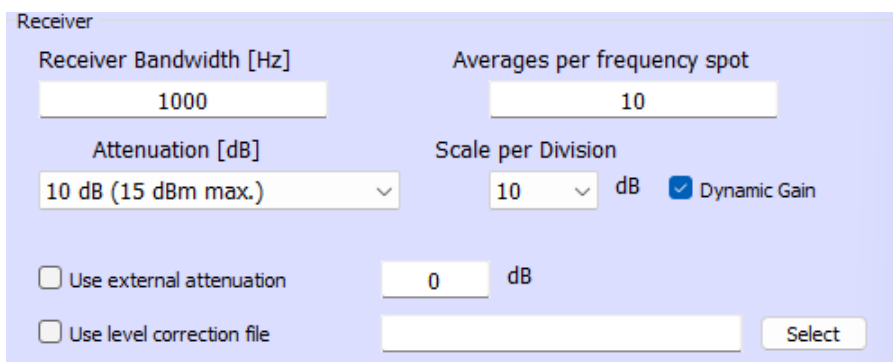

Figure 2-34 Receiver Menu

The receiver bandwidth specifies the greatest resolution bandwidth used during the sweep. At low frequencies, especially during a logarithmic sweep, the bandwidth is automatically reduced to more appropriate values.

Dynamic gain control is recommended for a maximum dynamic range of 110 dB. With dynamic gain control enabled, the preset attenuation refers to the maximum attenuation, which is automatically adjusted to maximize the measurement's dynamic range.

External attenuators or other additional components in the measurement path can be compensated using the external attenuation setting and appropriate level correction files.

Furthermore, averaging can be employed to smooth out the measurement graph.

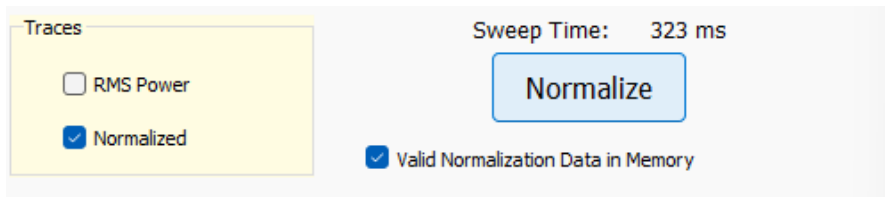

Figure 2-35 Normalization Menu

Upon successful normalizing, a checkbox will indicate that valid normalisation data has been stored to the memory. Both the normalized trace and the non-normalized trace can be displayed.

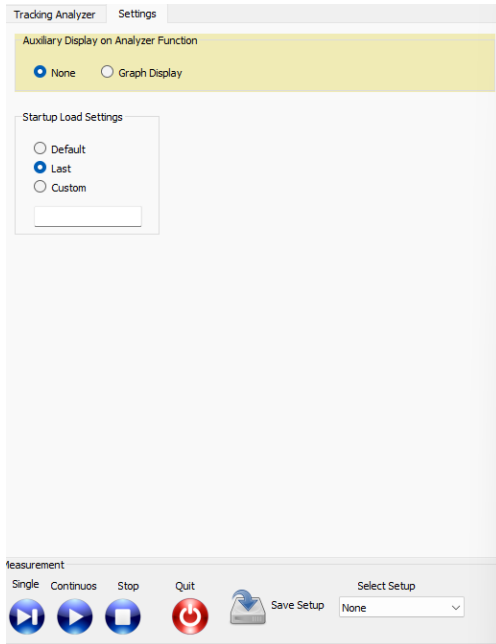

Figure 2-36 Startup load settings tab

Configure the appearance of the tracking analyzer after startup. When using any TBMR-110M application, it is recommended to arrange the app window and graph window according to personal preference and configure the “Startup Load Settings” to “Last”.

- **“Default” Startup:**
The application window will pop up in the center of the display. The graph window can be attached to the application window, by pressing the “CTRL” button, while shifting it with the mouse. With the next start of the app, the relative position of the graph window with respect to the app window will be restored.
- **“Last” Startup:**
Restarts the application with the settings from the previous session.
- **“Custom” Startup:**
Restarts the application using a custom configuration. The setup must be found among the saved setups. The name of the setup must be entered manually.

If desired, the auxiliary TFT display on the TBMR-110M's front panel can be configured to display graph data.

2.7 Oscilloscope Application

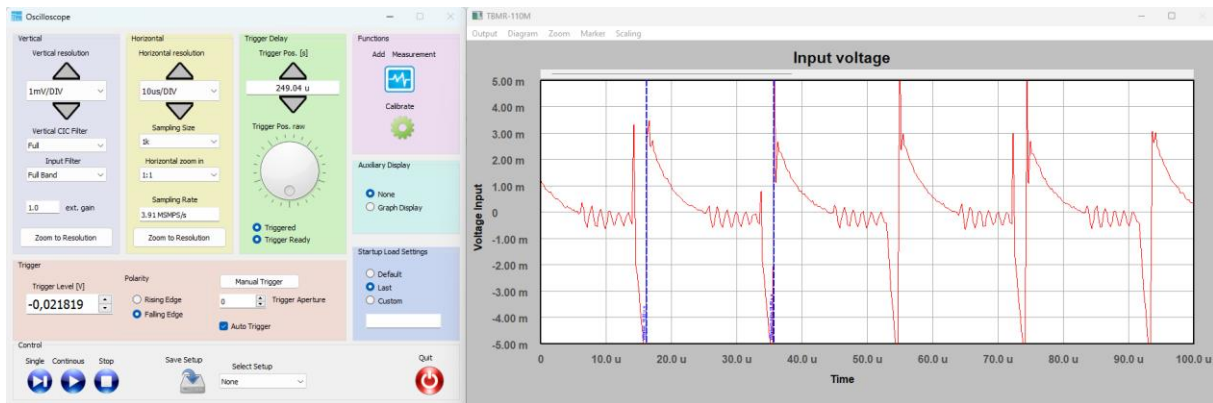



Figure 2-37 Oscilloscope application, DC to 110 MHz

The oscilloscope is useful, when the noise spectrum of an Equipment under Test has to be correlated with the time domain.

	<p>In contrary to a typical oscilloscope, the implementation in the TBMR-110M lacks a high impedance input and input protection.</p> <p>The input impedance is 50 Ohm and the maximum input rating decreases as the sensitivity settings increase.</p>
--	--

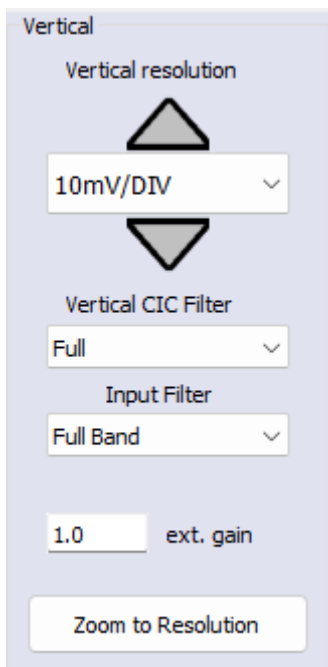
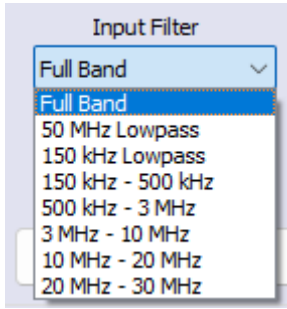

Figure 2-38 Vertical resolution settings

The oscilloscope feature would typically be used with the TBMR-110M connected to a 50 Ohm transducer such as a LISN or a current monitoring probe. Before connecting the RF input to the transducer, set the Vertical resolution to the minimum sensitivity (5V/DIV). Thereafter start the measurement in order activate the Overload Detection. Only then connect the instrument to the transducer. Then, progressively increase sensitivity to a level appropriate for investigating the signal. The oscilloscope has an outstanding sensitivity of 1µV/DIV.



Using an Input filter may be helpful in case of trigger problems

Figure 2-39 Input filter settings

Attenuation [dB]	Absolute Max. Input Level [dBm, dB μ V, V]
30	30 dBm, 137 dBuV, 7 V
20	30 dBm, 137 dBuV, 7 V
10	25 dBm, 132 dBuV, 4 V
0	15 dBm, 122 dBuV, 1.25 V
-10 (equivalent 10dB gain)	15 dBm, 122 dBuV, 1.25 V
-20 (equivalent 20dB gain)	15 dBm, 122 dBuV, 1.25 V
-30 (equivalent 30dB gain)	15 dBm, 122 dBuV, 1.25 V

Table 2-7 Absolute Maximum RF input power and corresponding attenuator / gain settings, exceeding these levels will cause permanent damage to the analyzer.

Always use an external attenuator/limiter, if you test an unknown EUT / source. Levels above the given input power / voltage rating (even for short bursts) will trigger an overload condition only during an active measurement.

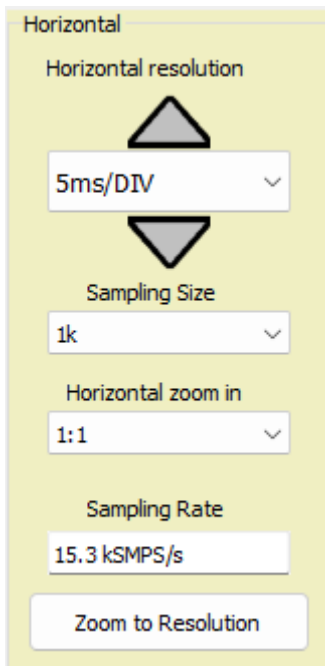

The horizontal resolution can be changed between 1ns/DIV and 1s/DIV.

Figure 2-40 Horizontal resolution settings

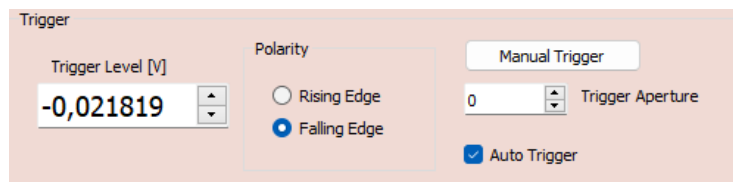
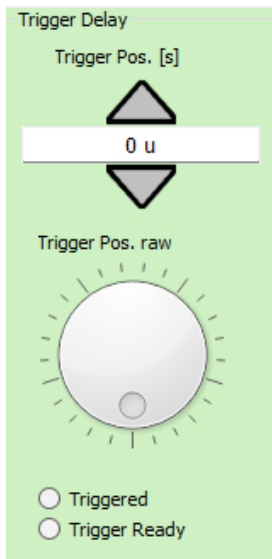

Use the trigger function to synchronize the horizontal sweep at the correct point of the signal. The default trigger position is shown as a green vertical line on the left side of the graph window. To see the signal before the trigger event, use the arrow or wheel to move the trigger position to the right. If a noisy signal prevents stable triggering, increase the value of the trigger aperture. If increasing the trigger aperture results in increased jitter, try reducing the noise with an adequate input filter setting. To utilize the manual trigger button, un-check the Auto Trigger box.

Figure 2-41 Trigger settings

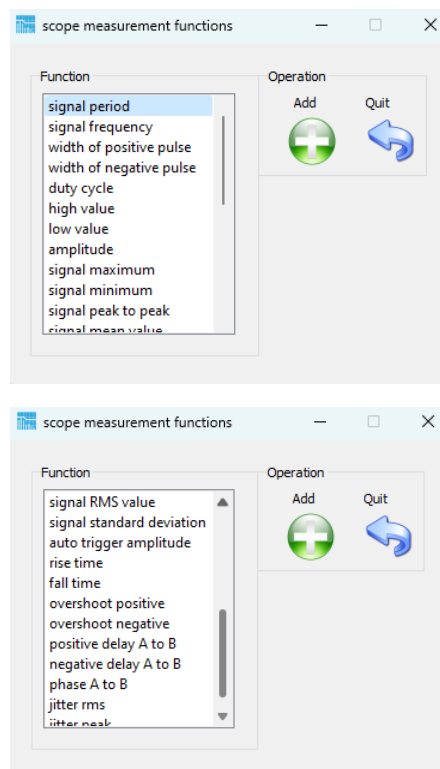
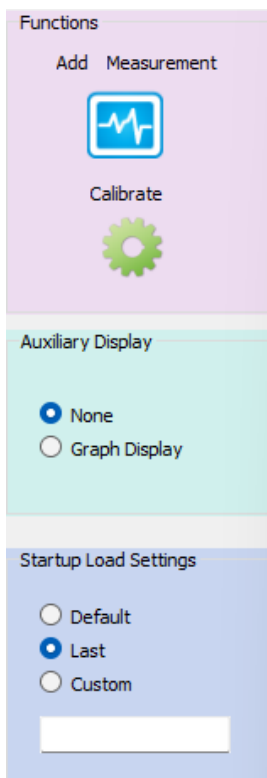

Figure 2-42 Scope measurement functions; Auxiliary display and Startup Load settings

Press the add measurement button to select from the numerous scope measurement functions.

The results of the selected measurement functions are displayed in text boxes, comparable to the markers, on the graph window.

The settings for the auxiliary display and the start-up load settings work same as with the EMI analyzer or spectrum analyzer.

2.8 Demodulator Application

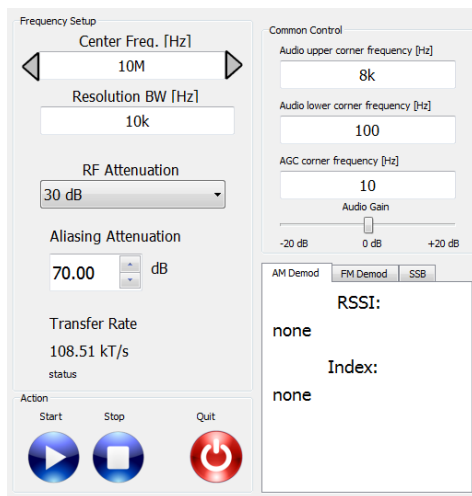

Figure 2-43 Demodulator panel

The demodulator application allows to utilize the TBMR-110M to demodulate an RF signal and transfer it to the computers sound card. Any sound processing, recording or analysis software can be used to select the demodulated audio as input signal. The following parameters can be configured:

- **Center Frequency**
This value shall be set to the signal carrier frequency.
- **Resolution Bandwidth**
Occupied -3 dB bandwidth of the modulated signal.
- **RF Attenuation**
Set the attenuator according to the expected signal level.
- **Aliasing Attenuation**
Should be kept at 70 dB; allows to change the required signal-to-noise ratio and data transfer rate.

Due to USB speed limits, the transfer rate must not exceed 1000 kT/s. One transfer consists of eight bytes: four bytes of in-phase data and four bytes of quadrature-phase data.

The "Common Control" group allows you to configure audio parameters such as upper and lower audio signal corner frequencies, automatic gain control, corner frequencies, and audio gain. The three tabs in the right bottom corner of the demodulator window allow you to select a demodulator.

AM (amplitude modulation)-Demodulator:

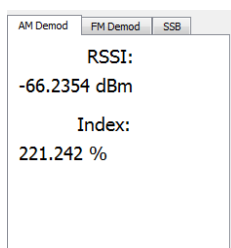

Figure 2-44 AM Demodulator tab.

If the AM demodulator tab is selected and the demodulator is launched, the box will display the following parameters:

- RSSI : Radio Signal Strength Indicator in dBm
- Modulation Index

FM (frequency modulation) - Demodulator:

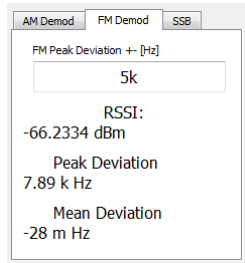

Figure 2-45 FM Demodulator tab.

FM is characterized by its frequency deviation: The FM peak Deviation

For narrowband FM the peak deviation is typically +/- 5 kHz (e.g. CB radio)

For wideband FM it is typically +/- 75 kHz (e.g. FM radio)

Following parameters are measured:

- RSSI : Radio Signal Strength Indicator in dBm
- Peak Deviation : Shows the peak deviation from the center frequency
- Mean Deviation : Shows the difference between the actual modulated carrier frequency and the configured center frequency. If the center frequency of the modulated signal equals the carrier frequency, the value should be zero

SSB (single sideband) - Demodulator:

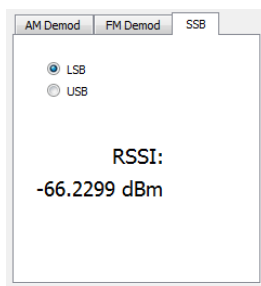

Figure 2-46 SSB Demodulator tab.

The type of SSB demodulator can be selected by the two radio-buttons

- LSB lower sideband
- USB upper sideband

Moreover, average band power is measured and displayed.

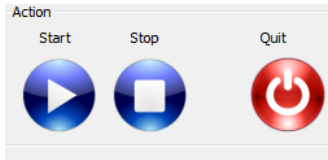

Figure 2-47 Action buttons.

The demodulation process is started with the Start button and stopped with the stop button. During an active demodulation process it is only possible to change the center-frequency and the audio controls. It is not possible to switch the demodulator type.

2.9 Remote Control Application

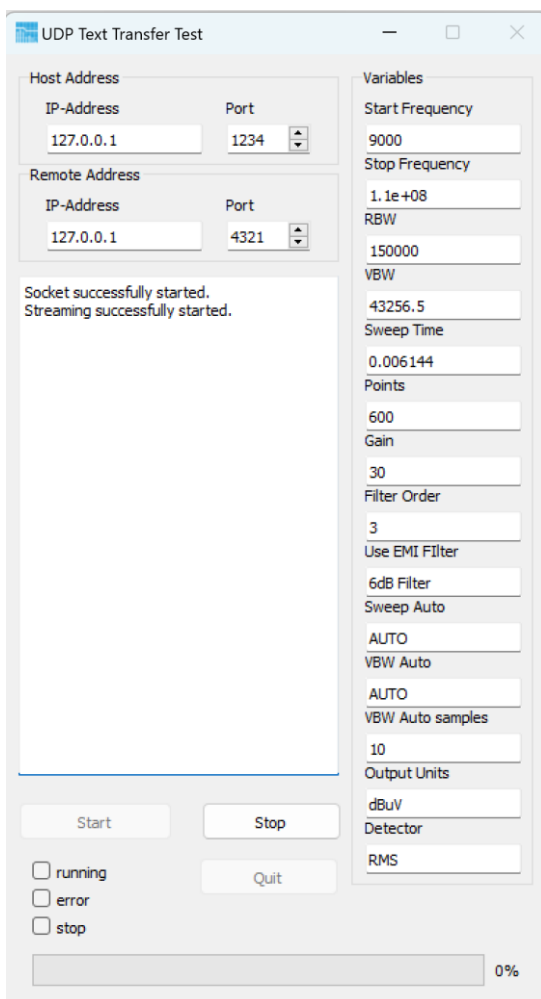

Figure 2-48 Remote Control Window

The Remote Control Application establishes a bidirectional UDP channel.

Refer to the Appendix for information on how to use the Remote Control Application for other purposes. The various variables in the GUI can be used to verify the remote controlled settings and the status windows will prompt any communication with the Host.

EMCview for TBMR-110M

A customized version of EMCview comes as an accessory. However, due to the frequency range of the TBMR-110M, not all operation modes of the conventional EMCview (PRO) software are accessible.

Launch the EMCview installer provided on the USB stick with the TBMR-110M software.

After installation, turn on the TBMR-110M and connect it to the PC, using the supplied USB cable. Launch EMCview and enter the “Connect” menu.

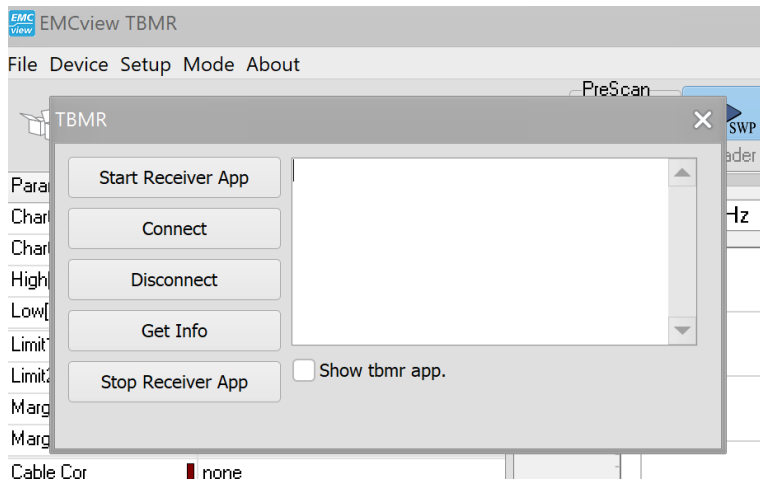

Figure 2-49 EMCview Device connection window

Press “Start Receiver App” and then “Connect”. EMCview starts the TMR-110M software and the remote application in the background. It will only be seen in the Windows task manager.

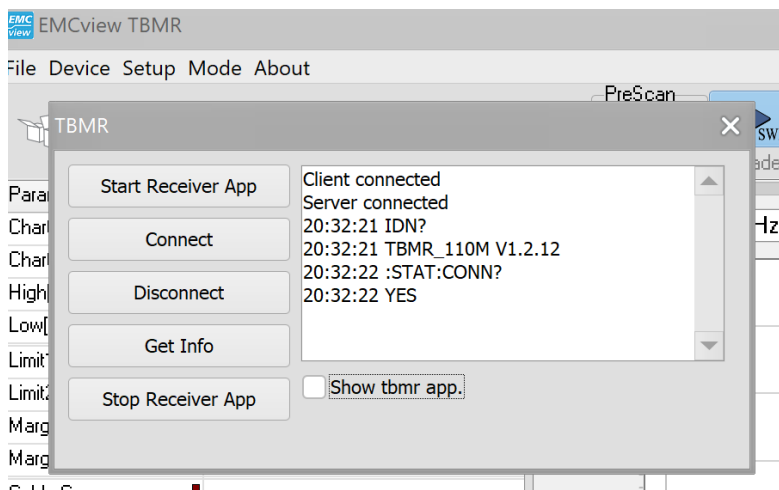

Figure 2-50 EMCview connected to TBMR-110M

Close the connection pop up window, clicking “X” and start using EMCview.

Refer to the EMCview manual and EMCview document for instructions on how to operate the software. Operation modes such as RF-coverage measuring and immunity-testing are inaccessible. Preconfigured radiated emission tests are also not available.

Because of the control and data transfer over UDP channel, measurements are slower than using the TBMR-110M software.

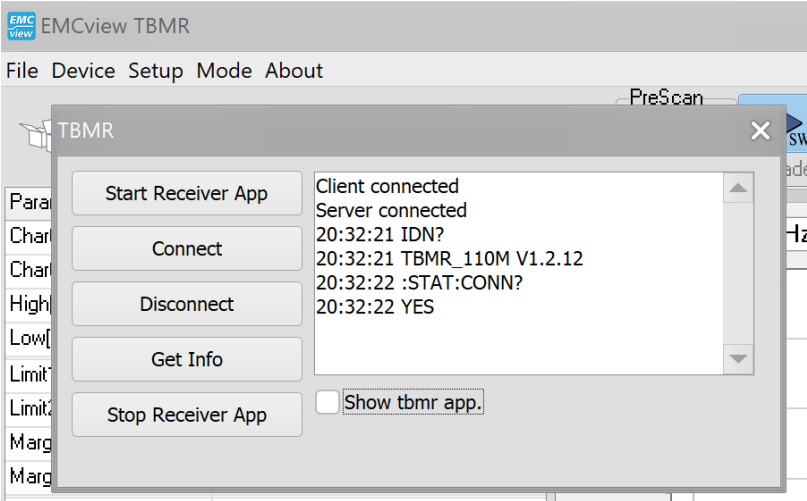

Figure 2-51 EMCview connected to TBMR-110M

After completing measurements, go to the “Device” menu, and select “Disconnect” and then “Stop Receiver App”. EMCview is ready to be shut down now.

If you forget to press the “Stop Receiver App” button and wish to use the TBMR-110M software, close it using the Windows Task Manager and then launch it normally.

2.10 I/Q Data Streaming Application

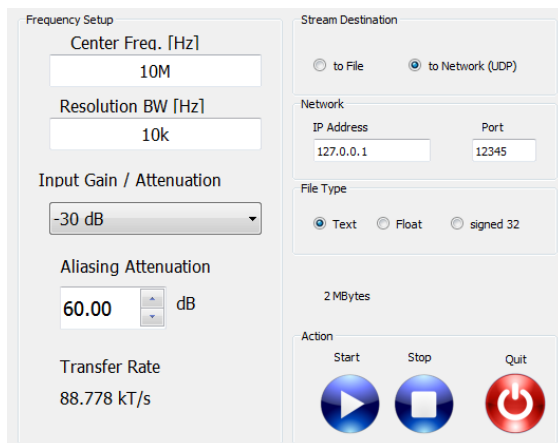

Figure 2-52 I/Q Data Streaming Application.

The I/Q Data streaming application allows you to store or transfer sampled baseband in-phase and quadrature-phase data words to a disc or network. These so called I-Q data words allow processing and demodulation of sophisticated modulation schemes. The signal at the selected center-frequency will be down-converted to the baseband and filtered according to the resolution bandwidth setting. Down-sampling will be automatically applied to reduce the transfer rate. The aliasing attenuation setting limits the maximum down sampling factor in order to maintain the given signal to noise ratio. 60 dB will suffice for most applications.

The continuous data stream can be either sent to a file or across a network using UDP protocol. The data-type of the streaming file can be Text, binary 4-Byte floating point or 4 Byte signed integer.

The network streaming option can be used as a data source in GNU-Radio:

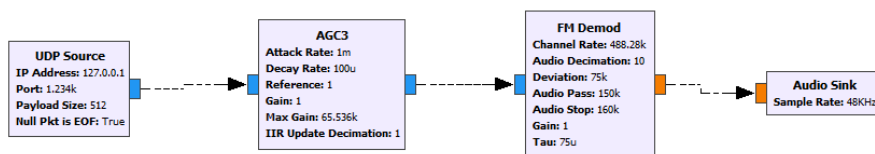

Figure 2-53 Simple FM Demodulator in GNU-Radio using the TBMR-110M as data source.

For the data source a UDP source is selected and the IP address and port settings must match the parameters in the streaming application GUI. Payload Size has to be set to 512 Bytes.

The transfer rate is limited to 1000 kT/s due to USB speed limitations

3 Appendix

3.1 EMI measurement correction – Transducer characteristics

EMI measurement setups incorporate transducers such as measurement antennas, RF current monitoring probes, or LISN, to name the most common.

All transducers have characteristics that must be taken into account for accurate measurement results.

- **Measurement Antennas:**

Measurement antennas are characterized by their antenna factor AF in [dB/m].

Measurement antennas always come with an antenna factor table.

Adding the electrical antenna factor to the voltage at the antenna output in [dB μ V] delivers the corresponding electrical field-strength in [dB μ V/m].

$$\text{Electrical field-strength } E[\text{dB}\mu\text{V}/\text{m}] = V_{\text{ANT}}[\text{dB}\mu\text{V}] + AF_E[\text{dB}/\text{m}]$$

Antennas that are designed to measure magnetic fields are characterized by the magnetic antenna factor in [dB/ Ω m]

$$\text{Magnetic field-strength } H[\text{dB}\mu\text{A}/\text{m}] = V_{\text{ANT}}[\text{dB}\mu\text{V}] + AF_H[\text{dB}/\Omega\text{m}]$$

The antenna factors are always frequency dependent and, to a lesser extent vary depending on the measurement distance between antenna and Equipment Under Test.

- **RF Current Monitoring Probes:**

RF current monitoring probes are characterized by their transimpedance. The transimpedance characterizes the sensitivity of the probe, or how the current passing through the aperture translates into voltage at the probe's output. In linear terms, transimpedance is specified in [V/A] or [Ω]. EMC limits for currents are specified in [dB μ A]. Consequently, transimpedance is typically specified in [dB Ω]. In order to translate the probe voltage into the corresponding current, simply subtract the transimpedance value.

$$I[\text{dB}\mu\text{A}] = V_{\text{PROBE}}[\text{dB}\mu\text{V}] - \text{Transimpedance}[\text{dB}\Omega]$$

RF current probes always come with a table containing the transimpedance values versus frequency.

- **Line impedance Stabilization Networks (LISN):**

LISN are characterized by their impedance, phase, isolation and voltage division ratio. The relevant parameter for measurement correction is their voltage division ratio, which characterizes the ratio of the voltage at the LISN RF port and the voltage at the LISN EUT port.

The actual measurement setup may contain additional components that must be accounted for when calculating the measurement result. These components may include cables, attenuators, filters, limiters, amplifiers and other transducers.

All these components are characterized by logarithmic parameters, which can be easily added or subtracted from the raw data measured by the receiver.

Following formula is implemented in the TBMR-110M software and in EMCview:

$$\text{Graph amplitude} = \text{Raw amplitude}[\text{dB}\mu\text{V}] - \text{Cable file} - \text{LISN file} + \text{Antenna file} - \text{Amplifier file}$$

Any components can be characterized in any of the files. The software identifies the files by their extension:

- Cable files: *.cac
- LISN files: *.lsc
- Antenna files: *.ant
- Amplifier files: *.amp

Any component can be defined in any of the files, as long as the parameter has the appropriate sign. For example, the attenuation value of an attenuator must be negative in cable, LISN or amplifier files, but positive in antenna files. Current probes are defined in LISN files with positive transimpedance values.

3.2 Compensation File Format

Two alternative text file formats, a standard format and the EMCview format are supported by the TBMR-110M software. In any case, a logarithmic correction value is assigned to a frequency value.

Compensation (correction) files are stored in the C:\User\xyz\Tekbox\TBMR-110M\EMC_Standards\COMP folder.

	<p>The TBMR-110 software supports both a “standard” format and the EMCview correction file format.</p> <p>However, EMCview only supports the EMCview correction file format.</p>
---	--

The standard format is composed of both values in a line, as shown below:

<Frequency in Hz><Separator><Correction Value><Space><dB><CR,LF>

Valid separators are ",", ";", " ", and Tabulator.

An example of a compensation file with 0 dB gain at 1kHz, 1dB at 2 kHz and 2dB at 3 kHz:

```
1000, 0.0 dB
2000, 10.0 dB
3000, 20.0 dB
```

Examples with other separators:

```
1000;0.0 dB
```

or

1000 1.0 dB

The frequency values must be in ascending order

The EMCview compensation file format has the frequency and corresponding correction value in consecutive lines:

```
[Application]
[Data]
Freq1=250000000
Lev1=17.77
Freq2=255000000
Lev2=15.74
Freq3=260000000
Lev3=14.34
Freq4=265000000
Lev4=14.23
Freq5=270000000
Lev5=14.27
```

The TBMR-110M and EMCview software differentiate the compensation files by their file extensions:

- Cable files: *.cac
- LISN files: *.lsc
- Antenna files: *.ant
- Amplifier files: *.amp

For further information on the EMCview File format, please consult the corresponding manuals.

3.3 Project File Format

The TBMR-110M uses Project Files to create preconfigured setups for the EMI Analyzer Application. The project file folders contain conducted emission tests for all common EMC standards.

Project files are stored in the C:\User\xyz\Tekbox\TBMR-110M\EMC_Standards\123\CN\ folders and have the file extension <*.prj>:

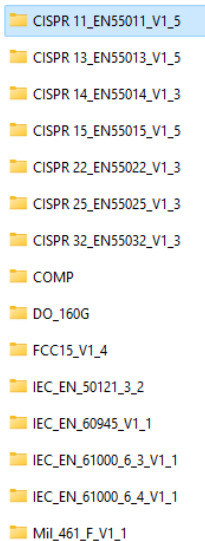

Figure 3-1 Folders with implemented EMC standards

Below a project file example for CISPR 32 (EN 55032) Class B, emissions on mains supply lines:

[Application]	<i>Header</i>
Product=TekBox Measurement Receiver	
Date=03/04/2023 12:21:28	
[SetUp]	
Start_Hz=150000	<i>Start frequency</i>
Stop_Hz=30000000	<i>Stop frequency</i>
High_Pegel=80	<i>default diagram Y-axis setup, upper limit</i>
Low_Pegel=0	<i>default diagram Y-axis setup, lower limit</i>
DETECTOR=CISPR16	<i>filter characteristic / detector standard</i>
LIMDET1=AVG	<i>detector for limit line 1, Average</i>
LIM1=CN_CISPR32_EN55032_CLASS_B_Mains_AVG.lim	<i>name of Limit 1 file</i>
LIMDET2=QP	<i>detector for limit line 2, Quasi-Peak</i>
LIM2=CN_CISPR32_EN55032_CLASS_B_Mains_QP.lim	<i>name of Limit 2 file</i>
CABLE=testcable.cac	<i>Name of cable compensation file</i>
AMP=none	<i>Name of cable compensation file</i>
ANT=none	<i>Name of antenna factor file</i>
LISN=Tekbox_TBLC08_ATT_ON.lsc	<i>Name of LISN file</i>

To create your own project file, open an existing project file with an ASCII text editor and save it with the desired name in the desired folder below C:\User\xyz\Tekbox\TBMR-110M\EMC_Standards\
Keep the header and configure the start and stop frequency of the sweep.

Next, set the desired Y-axis limits of the diagram.

Most EMC tests require a CISPR filter and CISPR detectors. Configure the detector parameter to <CISPR16>. When implementing a MIL-STD or DO-160 project, configure the detector parameter to <MILSTD461>

Enter the file name and the detector for the first limit line. The implemented options include <AVG>, <PEAK>, <RMS> and <QP>. It is important to note that the detector does not always refer to the detector used for the measurement. The detector denotes the detector specified in the EMC standard for the corresponding limit line. During a pre-scan measurement, the PEAK detector will be used instead of the QP detector. The QP detector will then only measure peaks that are above the QP Limit line.

Likewise for the second limit line. Most EMC standards, though not all, require conducted emission tests with two limit lines. If there is only one limit line, delete the lines that refer to the second limit line.

The final four lines of the project file refer to the compensation files. Enter the <file names> or <none> if it is not required.

In contrary to EMCview, the TBMR-110 project files do not specify gain or attenuation.

Upon starting the EMI Analyzer, the receiver attenuation is set to 20 dB. Once you've confirmed that there are no signals with excessive amplitude, you may want to reduce attenuation or increase gain to achieve adequate dynamic range. For a CISPR-compliant measurement, the base noise floor must be at least 6 dB lower than the limit line's lowest level.

3.4 Limit File Format

EMC standards specify limit lines as emission levels that must not be exceeded in order for a product to be compliant.

Limit files are referenced in project files, which are preconfigured setups for the EMI Analyzer application.

Limit files are stored in the C:\User\xyz\Tekbox\TBMR-110M\EMC_Standards\123\CN\ folders and have the file extension <*.lim>

The folders include both project and limit files. Each project file must have corresponding limit files in the same directory.

The TBMR-110 software re-uses limit files that were originally created for the EMCview software

Below an example for CISPR 32 (EN 55032) Class B emission limits on mains supply lines:

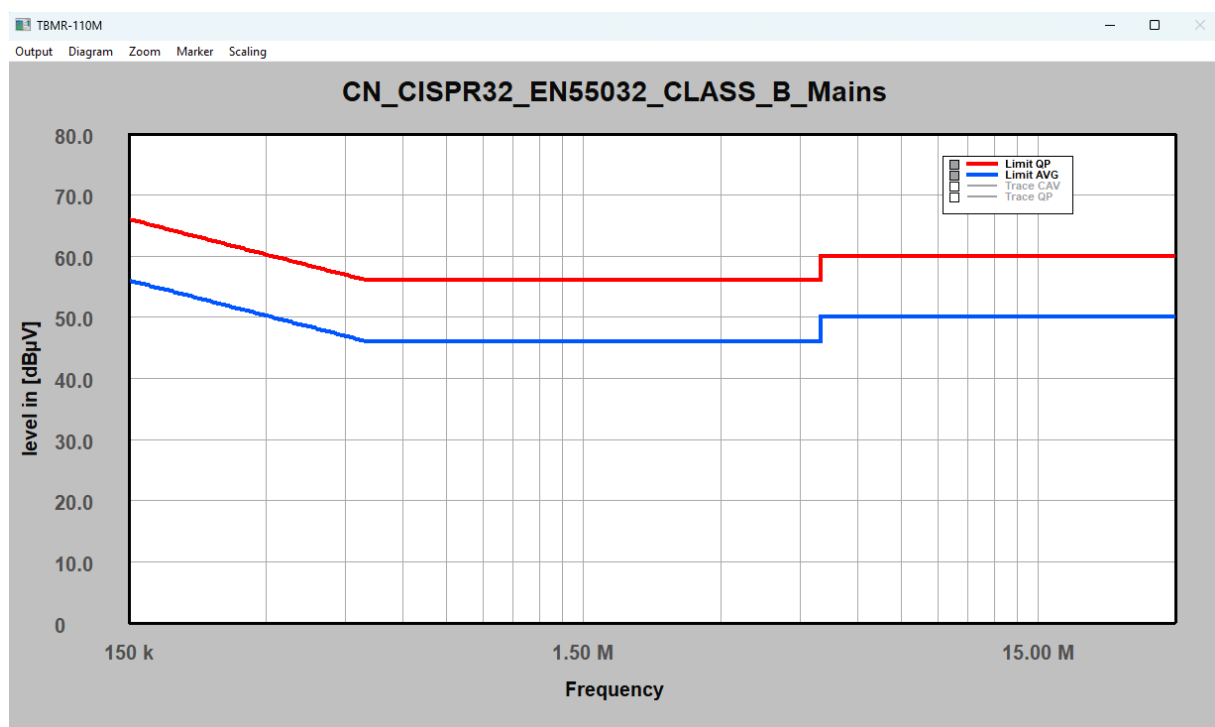

Figure 3-2 Conducted emission limits

CISPR 32 (EN 55032) specifies limits for measurements with Average and with Quasi-Peak detector.

The limits for average are always lower than those for quasi-peak. A measurement with the Average detector has a lower amplitude than a measurement with the Peak or Quasi-Peak detectors. A measurement taken with the Quasi-Peak detector has an amplitude that is equal to or greater than that of an Average detector but less than or equal to that of a Peak detector. As a result, if the emissions measured with the Peak detector do not exceed the Quasi-Peak limit, the product can be considered compliant.

Frequency range [MHz]	Coupling device	RBW	Detector	Limit [dB μ V]
0.15 – 0.5	50 μ H LISN	9kHz	Quasi Peak	66 – 56 Decreasing linearly with the logarithm of the frequency
			Average	56 – 46 Decreasing linearly with the logarithm of the frequency
Quasi Peak			56	
Average			46	
Quasi Peak			60	
Average			50	
0.5 - 5				
5 -30				

Figure 3-3 Conducted emission limits for CISPR 32, Class B, power supply / mains power ports

Based on the limits in the table above, the limit file for the Average detector should be fairly self-explanatory.

```
[Application]
Software=TekBox RP-W32-D11
Version=EmcView V08.50
Date=03/04/2023 12:21:28
[General]
Name=CN_CISPR32_EN55032_CLASS_B_Mains_AVG.lim
Level_Interplot_Mode=log
Units=dB $\mu$ V
[Data]
Freq1=150.000
Lev1=56
Freq2=500.000
Lev2=46
Freq3=5.000.000
Lev3=46
Freq4=5.000.010
Lev4=5
Freq5=30.000.000
Lev5=50
```

To create your own project file, open an existing project file with an ASCII text editor and save it with the desired name in the desired folder below C:\User\xyz\Tekbox\TBMR-110M\EMC_Standards\

Keep the header, and change the file name accordingly.

The level interplot parameter <log> implements the standard requirement for linear interpolation with the logarithm of the frequency.

The Units parameter specifies the unit of the Y-axis of the diagram.

Enter the limit line's corner points as consecutive frequency/level pairs, ascending in order.

Whenever there is a vertical step, use a steep line with a frequency offset of a few Hz for the corner points. Such a step is carried out between points 3 and 4 of the above limit line. Both points are offset by 10 Hz.

3.5 Equation Syntax

The equation field allows you to define an output trace by entering an output equation, providing complete flexibility in custom units or special trace functions. “Processed” source values (variables) use the unit configured in “Trace functions”. Internal source variables are in the linear domain, with no external gain or correction file. The linear values are such that

$$P(\text{dBm}) = 20 * \log_{10}(\text{value}) \quad \text{with } \text{value} = \frac{V_{\text{eff}}}{\sqrt{50 \cdot 1\text{mW}}} = \frac{V_{\text{eff}}}{0.2236}$$

Available operators, listed top to bottom, in descending precedence:

Operator	Description
^	Power function
*	Multiply
/	Divide
+	Add
-	Subtract

Table 3-1 Equation; Standard Operators

The equation editor accepts standard brackets (), floating-point numbers and the following constants and variables:

Constant/Variable	Description
FREQ	Frequency
W	Frequency * 2 * PI
PI	3.14159...
CORR	Linear value (not in dB) of correction file for the current frequency
MEM	Linear value (not in dB) of the memory file for the current frequency
RBW	Resolution bandwidth in Hz
VBW	Video bandwidth in Hz
ATT	Linear value of the external gain field
BAND	Band power: 20 * log10(band power) is band power in dBm

Table 3-2 Equation; Constants and Variables

Following source variables are available

Source Data	Description
value.rms	RMS detector value for the current frequency position
value.avr	Average detector value for the current frequency position
value.max	Positive Peak detector value for the current frequency position
value.min	Negative Peak detector value for the current frequency position
peak.rms	Highest RMS detector value of the last sweep
peak.avr	Highest average detector value of the last sweep
peak.max	Highest positive peak detector value of the last sweep
peak.min	Lowest negative peak detector value of the last sweep
processed.rms	RMS detector value in the currently configured unit
processed.avr	Average detector value in the currently configured unit
processed.max	Positive peak detector value in the currently configured unit
processed.min	Negative peak detector value in the currently configured unit

Table 3-3 Equation; Available Source Data Identifiers

Following functions f(x) can be applied:

Function	Description
ABS()	Absolute value of complex number
ARG()	Phase of complex number in radians
DB10()	$10 \cdot \log_{10}(x)$
DB20()	$20 \cdot \log_{10}(x)$
LOG()	$\log_{10}(x)$ logarithm to the base of 10
LN()	$\ln(x)$ logarithm to the base of e
EXP()	e to the power of x
SQRT()	Square root
SIN()	Sine
COS()	Cosine
TAN()	Tangens
COT()	Cotangens
ASIN()	Arcussine
ACOS()	Arcuscosine
ATAN()	Arcustangens
ACOT()	Arcuscotangens
SINH()	Hyperbolic sine
COSH()	Hyperbolic cosine
TANH()	Hyperbolic tangens
ASINH()	Arcus hyperbolic sine
ACOSH()	Arcus hyperbolic cosine
ATANH()	Arcus hyperbolic tangens
DBM()	Converts value to dBm
DBUV()	Converts value to dBuV
DBM1HZ()	Converts value to dBm/Hz
VOLT()	Converts value to rms Volt
WATT()	Converts value to Watt

Table 3-4 Equation; Available Functions

Examples:

Display dBm RMS:	<code>dBm(value.rms)</code>
Display Watt Average	<code>watt(value.avr)</code>
Display dBuW	<code>dBm(value.rms) + 30</code>
Display nV/Sqrt(Hz)	<code>volt(value.rms)/sqrt(RBW * 1.128)/1e-9</code>

3.6 The Diagram System

The TBMR-110M's diagrams all follow the same concept and are explained in the same chapter. All procedures or setups may not be possible on all diagrams and are application-dependent. For example, horizontal zoom may not be possible in the EMI analyzer application, and some traces cannot be removed or made invisible.

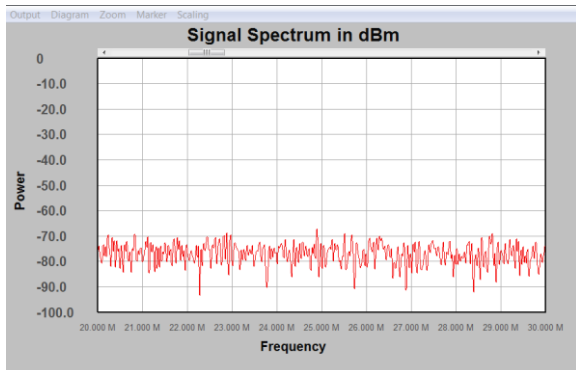

Figure 3-4 Example; rectangular diagram from the spectrum analyzer

There are many setup, display, and manipulation options available, which will be described in the coming chapters.

3.6.1 Move and glue the diagram to other windows.

The diagram window can be moved anywhere on the screen or between multiple screens using conventional Windows window manipulation methods such as moving the window title bar. Increasing the size of the window will automatically scale its contents and traces, as will maximizing. To prevent the dialog from disappearing, some apps may deactivate only the close window button.

Each diagram can be attached to the associated GUI dialog or other diagrams, if available. To stick to another window, press and hold the left key while dragging the window close to it. Each window can be "glued" to the right or bottom side of a different diagram or GUI panel. Either at the center of the edge or at the corner. If the diagram is close enough, it will be dragged to the other window when the left key is released.

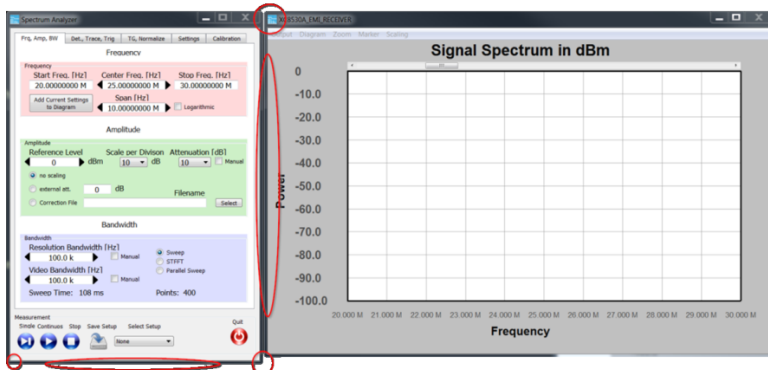

Figure 3-5 Possible "glue points" of a diagram (red marking)

To disengage the "glue effect," hold the left key and drag the diagram away from the window it is stuck to.

3.6.2 Print, Copy and Save diagrams.

The Output menu bar provides the following operations

- **Print**
This resizes the window to the current set printer page size and prints the diagram to the current printer.
- **Copy to Clipboard**
This will transfer the diagram's bitmap in its current size to the clipboard, which can then be pasted into another application for documentation purpose
- **Save Image**
This saves the bitmap of the current diagram to disk.

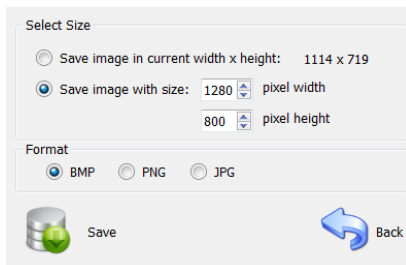

Figure 3-6 "save image" window

A dialog will appear to choose between a resize option and different file formats.

- **Close**
Closes the current diagram. The diagram will disappear.

3.6.3 Diagram Properties.

There are three ways to show the diagram properties dialog.

- To display the context menu, right click on an empty section of the diagram and select "Edit Diagram properties"

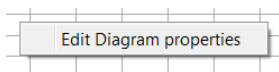

- Following dialog will pop up, when double clicking on an empty section of the diagram and selecting the "Properties" item from the "Diagram" menu.

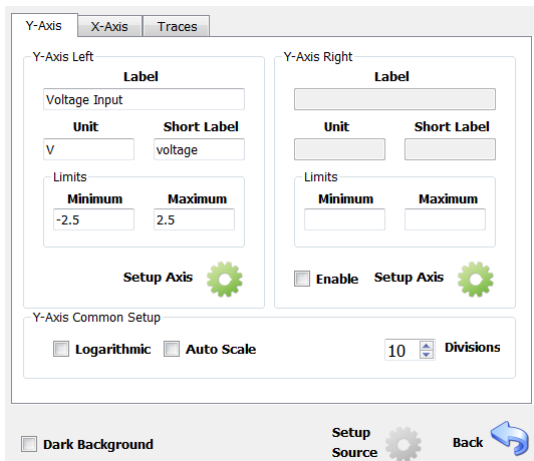

Figure 3-7 "Y-Axis" diagram properties tab

The first tab includes the Y-axis parameters. Please keep in mind that depending on how the diagram is used, the current program may disable various fields. For example, when using the spectrum analyzer, use the analyzer menu to scale the Y-axis. The Y-axis labeling may have two sides: left and right, which share the same grid lines but differ in offset and scaling. If necessary, the right y-axis can be activated. Traces can be assigned to the left or right axis.

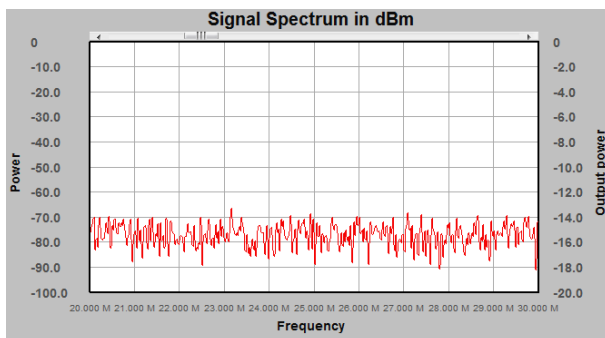

Figure 3-8 Diagram with two differently scaled y-axis

The "Label" field corresponds with the label displayed next to the axis, whereas the "unit" field contains the unit of the displayed traces. The "Short Label" field is utilized elsewhere, such as markers, and should be kept brief in length. The minimum value represents the axis's bottom value, while the maximum represents the top value. Check the "logarithmic" checkbox to make the y axis logarithmic, and enable autoscale if desired.

If the user prefers a dark design style for the diagram, selecting "Dark Background" will enable it.

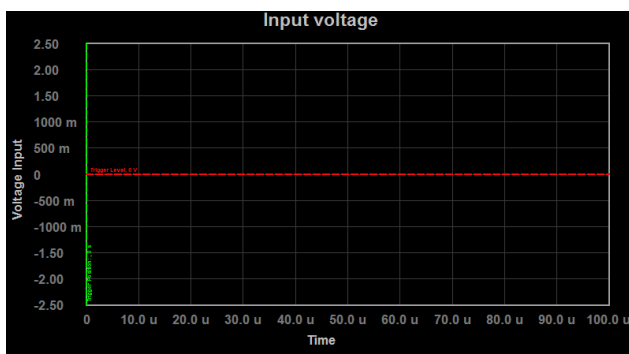

Figure 3-9 "Dark style diagram

The "Setup Axis" button will open a new window that allows you to comfortably scale the y axis. This menu can also be launched by double-clicking on the graph window's Y-axis.

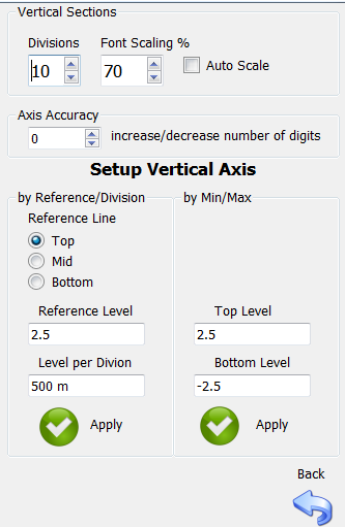

Figure 3-10 Y-Axis setup tab

Here, you may easily change the number of vertical gridlines and the font size. Furthermore, the axis' accuracy (decimals) can be modified as needed. Moreover, you can setup the Y-axis in relation to the reference level, or by a simple minimum and maximum level setting.

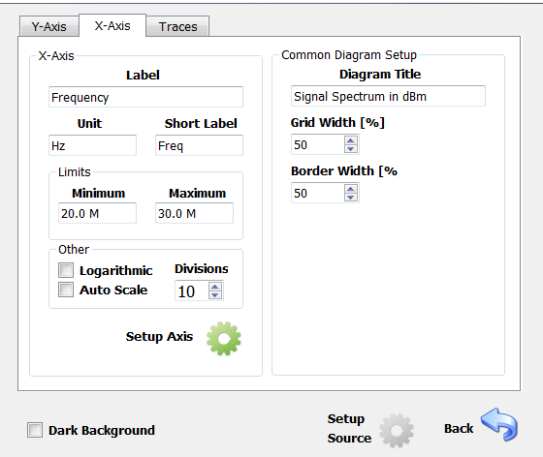

Figure 3-11X-Axis setup tab

Configure x-axis labels and the displayed frequency range. The x-axis can be set to either linear or logarithmic scaling, and Auto Scale can be enabled. For comfortable scaling, press the Setup Axis button.

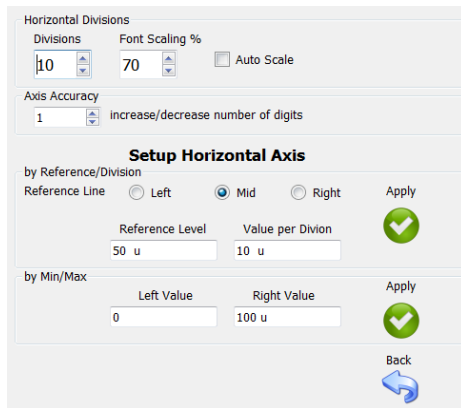

Figure 3-12 Horizontal-Axis setup tab

Double-clicking the X-Axis in the graph will also bring up the Setup Horizontal Axis menu, which provides quick access to scaling options.

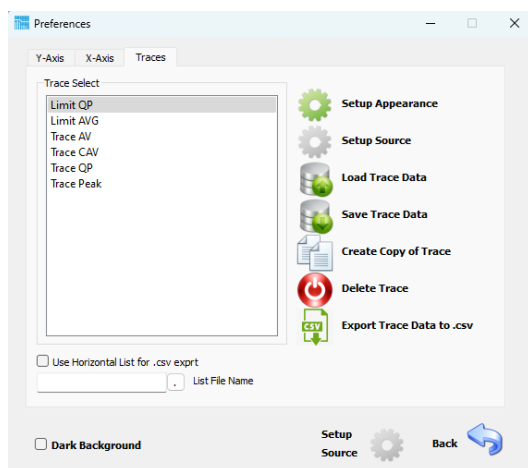

Figure 3-13 Traces setup tab

The Traces Setup tab shows a list of all the traces assigned to the diagram. Pressing the "Setup Appearance" button allows you to fine-tune each trace's settings. "Setup Source" is only enabled if the trace generating application permits to edit the trace-data generation setup. An application specific dialog will appear to configure further trace details.

Traces can be loaded and saved to/from the diagram, but once loaded, the data displayed is static and will not be modified by current or future measurements. Saved/loaded traces are used to document modifications or simply for comparison. A copy can also be made from a selected trace, but it will be a static duplicate and unaffected by measurements. Traces can also be deleted if the application supports it. Certain traces are locked and cannot be deleted. Moreover, trace data can be exported into a.csv file for external processing.

The Checkbox "Use Horizontal List for .csv export" will use an external list of x-axis values (for example frequency values), interpolate the corresponding Y value from the trace for each x-axis value in the list and save this data to the .csv file. This is useful when the internal x-values do not match the intended x-values. The data format is a simple text file with one x-value per text line.

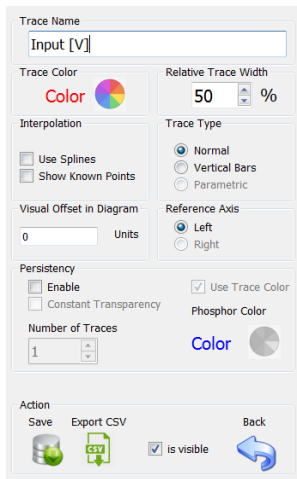



Figure 3-14 Trace appearance setup

The "Trace Appearance" dialog allows you to specify additional settings for the selected trace. You can change the trace name, click on the color wheel to change the trace color or change the line width of the trace.

The interpolation section facilitates to use "Spline" interpolation between data-points.

	<p>Under certain conditions, spline interpolation may cause over-or undershoot of the displayed graph. If you suspect non-physical behavior, switch to "Show Known Points" and compare</p>
--	--

"Show known Points" will display Dots for each "real" measurement point.

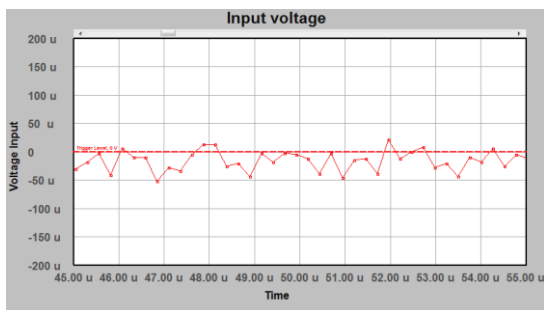
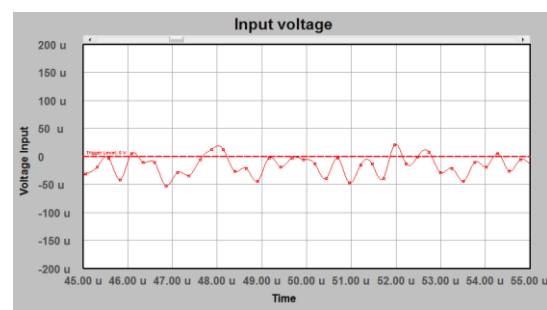

Figure 3-15 Displaying real data points (Show Known Points)



Same data points, spline enabled

The Trace Type section allows you to configure the trace data representation. The "Vertical Bars" setting will display the above data as:

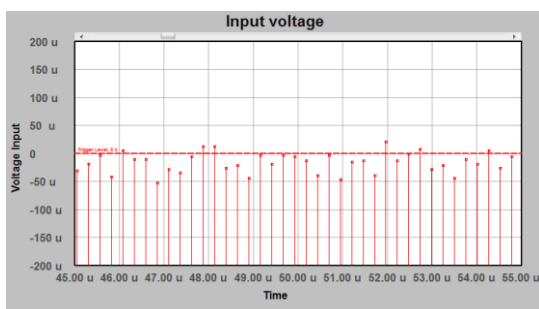

Figure 3-16 Same data points with vertical bars enabled

Another type of data representation is the "parametric" representation, which is only used in polar-plots and smith diagrams and includes complex numbers. It is not applicable for the TBMR-110M and greyed out.

Another useful extension is the application of Persistency. This concept dates back to the old analog oscilloscope storage CRT technology. A displayed trace will have some afterglow and become increasingly transparent with each subsequent measurement. The number of traces stored in "Afterglow" can be configured, with the oldest one having the highest transparency. However, "Constant Transparency" can be enabled, displaying all previous sweeps with the same transparency. Additionally, the color of the transparency can be adjusted.

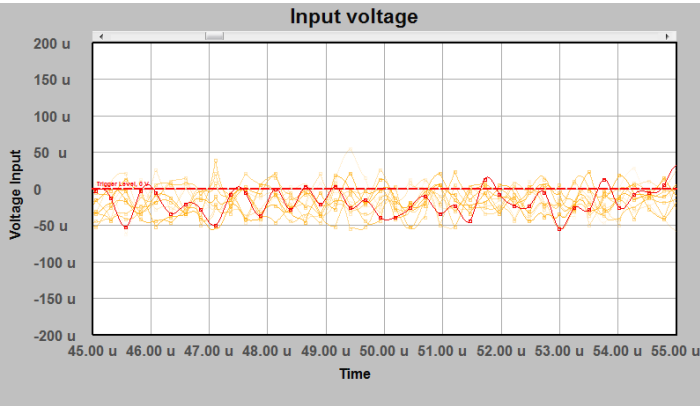

Figure 3-17 Diagram with ten traces, persistency with fading transparency and orange color

Moreover, the appearance setup dialog allows to save the trace data or to export it into a .csv file.

3.6.4 Quick Diagram Setup

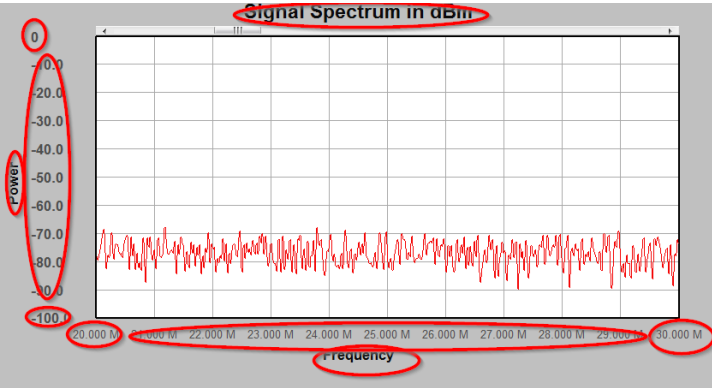

Figure 3-18 Content that can be edited directly

Double-clicking within the areas shown above allows you to enter data directly without having to navigate through the menu bar.

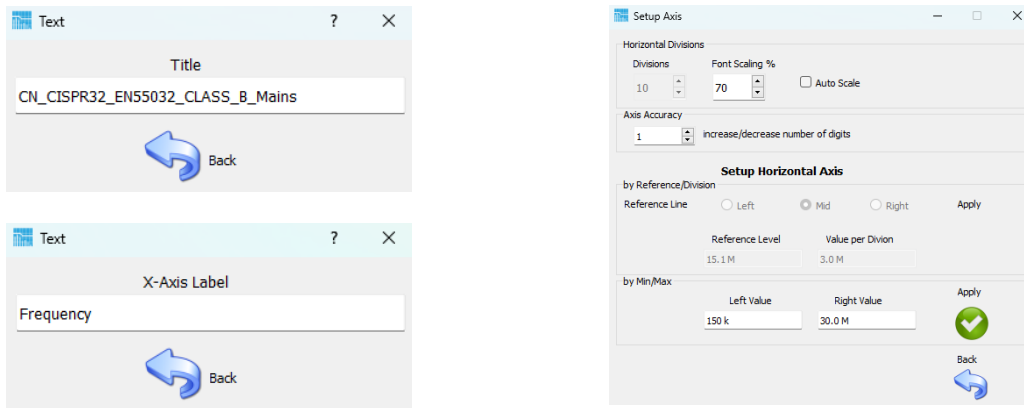

Figure 3-19 Example; dialogs upon double-clicking on diagram content

3.6.5 Trace selection and Trace Context Menu

Any trace can be marked with a single left click. The trace will be highlighted in yellow color.

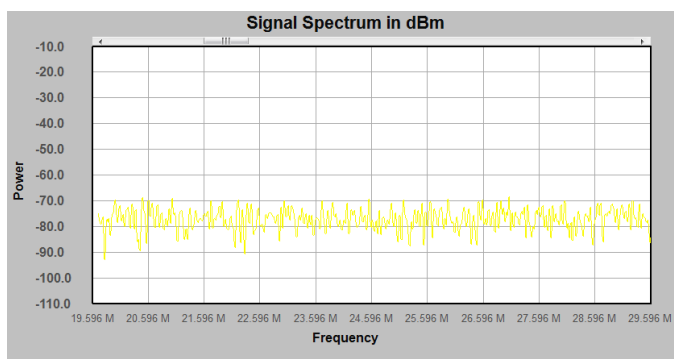

Figure 3-20 Highlighted trace

The following key/mouse combinations work on a highlighted trace:

- **<Delete>**
Will delete the selected trace, if the application allows it.
- **<Ctrl> + C**
Will make a copy of the currently selected trace.
- **Mouse double-click**
Will open the trace appearance setup dialog.

You can also use the menu: Diagram -> Copy Trace to make a copy of the selected trace.

Certain applications, such as the oscilloscope, allow you to offset a trace by dragging. Arrows will appear in trace-color to the right and left side of the diagram, showing the actual "zero" position of the trace.

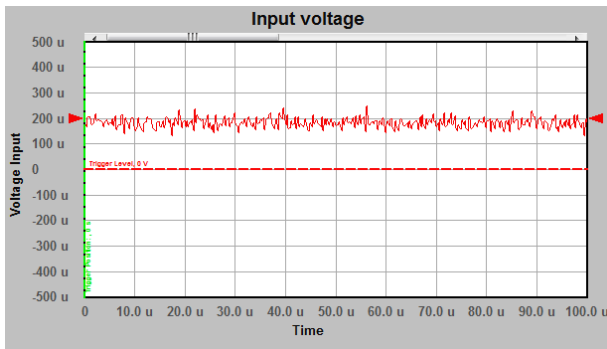

Figure 3-21 Trace with 200 μ V offset

Use this function to offset multiple traces with the same zero position, improving visibility.

Right clicking a highlighted trace brings up a context menu:

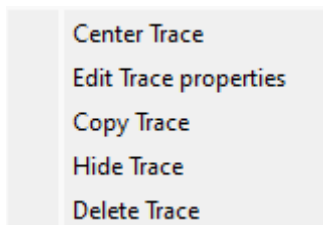

Figure 3-22 Trace context menu

- **Center Trace**
Removes any display offset
- **Edit Trace properties**
Opens the trace appearance dialog
- **Copy Trace**
Creates a copy of the selected trace
- **Hide Trace**
Makes a trace invisible without deleting it. To restore trace visibility, select the "is visible" checkbox in the trace appearance dialog of the Diagram Properties menu.
- **Delete Trace**
Deletes a trace, unless it is locked

3.6.6 Legend

To improve readability when there are multiple traces in a diagram, a legend label displays trace names and their corresponding trace colors. Create a legend for a diagram by:

- Selecting the Diagram menu -> Add Legend
- Or key combination <Ctrl> + L

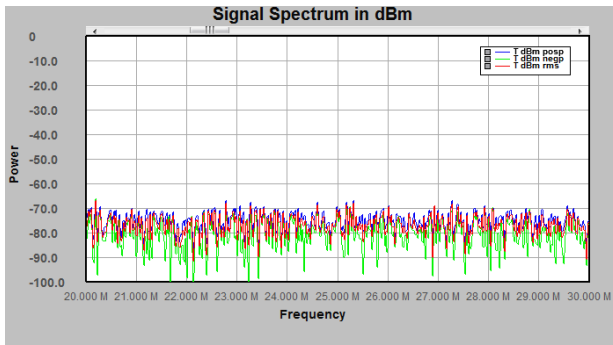
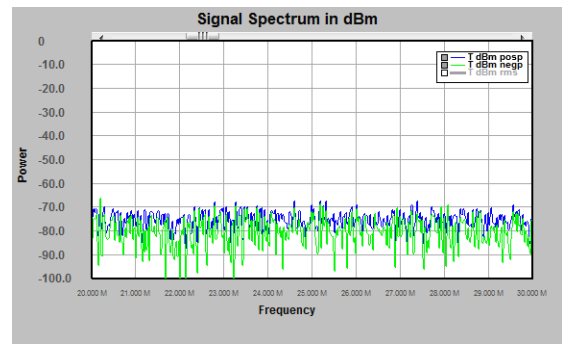

Figure 3-23 Legend label, displayed in the diagram corner



RMS trace set invisible

Trace visibility can be controlled by clicking on the boxes in the legend's trace list. Moreover, this feature helps to identify traces.

3.6.7 Label

Use labels to add customized text to the diagram. Each label can have up to 3 text lines.

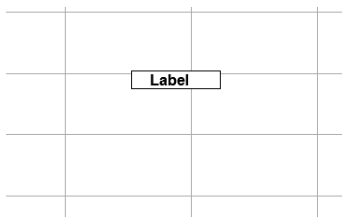
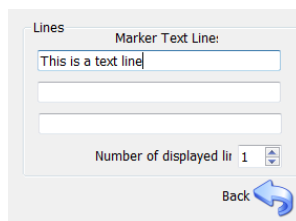

Figure 3-24 Example label



Label editor

The Diagram / Add Label menu brings up a label editor where you can enter up to three lines of text. Existing labels can be moved, deleted, or edited.

- **Move:**
Drag and drop
- **Delete:**
Left click the label to highlight it in red. Press the key or right click the label to access the context menu.
- **Edit:**
Double-Click the label or select the label, open the context menu and select "Marker properties".

3.6.8 Pan

To pan the display, click on an empty area of the diagram and move the mouse while holding down the left mouse key. It is able to pan along the X, Y, or both axes. The pan step width might be either one vertical or horizontal grid section. Please be aware that certain applications may have prevented panning and taken control of the diagram's position. Once a second right y axis is enabled, panning can be done on the left, both, or just the right Y axis.

The diagram area is divided into 3 horizontal sections to select the desired axis. Depending on where the mouse pointer is first clicked for panning, the corresponding axis is selected. The center area selects both axes.

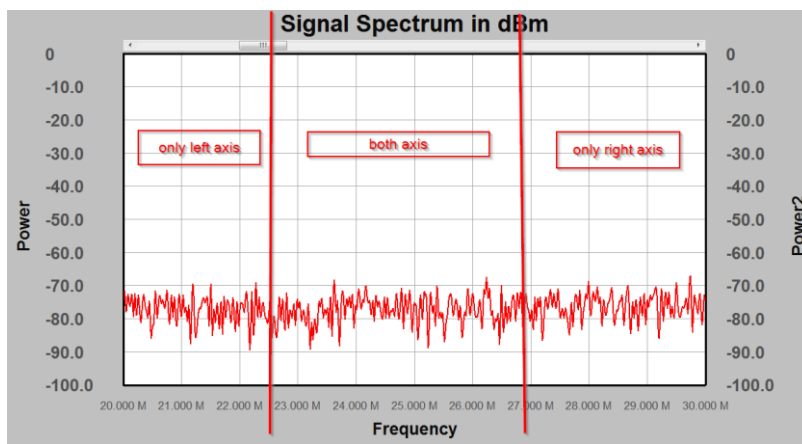

Figure 3-25 Y-Axis selection areas

The panning step grid can be disabled by pressing the modifier keys while panning, allowing for fine panning.

- <CTRL> + Horizontal pan
- <Shift> + Vertical pan

Certain applications disable fine panning.

3.6.9 Zooming

- **Horizontal Zoom**

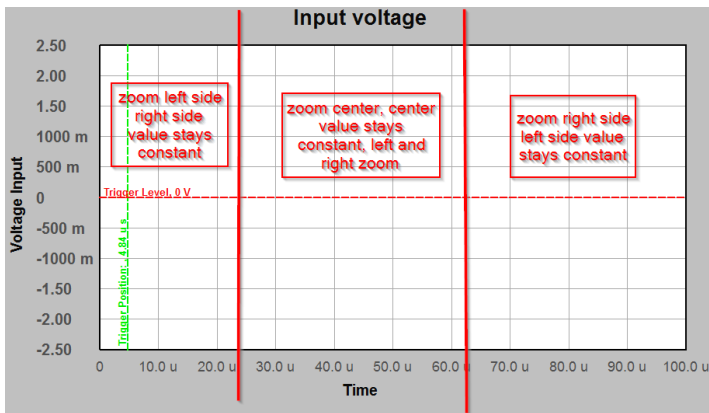

Figure 3-26 Horizontal Zoom selection areas

Horizontal zooming is done by using the mouse wheel without pressing any modifier keys or mouse buttons. Make sure the diagram window is active. The type of horizontal zooming is selected by the position of the mouse pointer. If the mouse pointer is positioned in the left area of the diagram while using the mouse wheel, the diagram's start position will change while the horizontal end position remains steady. Assume the trace is fixed in the above diagram at the right 100 us position, while the left side zooms in or out.

The same thing can be done on the opposite side. If the mouse pointer is near the center of the diagram, the zoom will keep the center value (above, the 50 us position) fixed while zooming the left and right sides in or out.

Please note that zooming can be disabled by some applications.

- **Vertical Zoom**

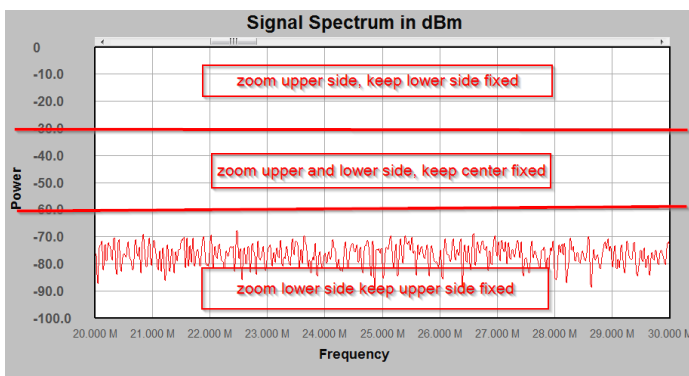

Figure 3-27 Vertical Zoom selection areas

The vertical zooms function similarly to the horizontal zoom. To zoom vertically, use the mouse wheel with the key pressed. Depending on where the mouse pointer is located in the diagram, the upper, lower, or center sections remain fixed while the others zoom. Please take note: The section where the mouse pointer is located will be zoomed. The other side remains constant. For the center section, the center value remains constant. In the case of two Y axes enabled, the above diagram can

be further sectioned as follows:

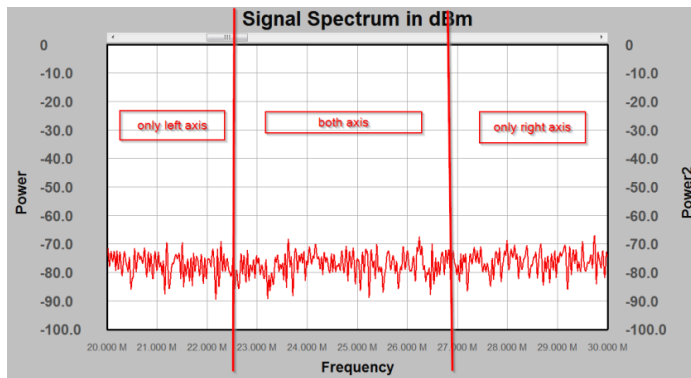

Figure 3-28 Further Zoom selection areas

In total, the diagram is divided into nine sections, with the mouse pointer allowing you to select the Y-axis and side to zoom in on.

3.6.10 Scaling

Scaling is selectable by the diagram menu "Scaling" and relates to one time or continuous auto-zoom, where the diagram's traces determine the X and Y position as well as scaling.

- Scale vertical (left and right); alternatively use the <v> key
Both Y axes (if available) will be zoomed to show all traces in the diagram window. Some margin at the top and bottom will be inserted.
- Scale vertical left; alternatively use the <l> key
Only the left axis will be zoomed to show all traces in the diagram window. Some margin at the top and bottom will be inserted.
- Scale vertical right also use the <r> key
Only the right axis (if available) will be zoomed to show all traces in the diagram window. Some margin at the top and bottom will be inserted.

Enabling Autoscale will always try to display all traces within the window.

However, Autoscale will not be available within all applications.

Horizontal zoom out is useful for re-centering a trace in the horizontal axis and can simply undo huge magnifications and pan. The <h>key also allows for horizontal zoom out.

3.6.11 Markers

Markers are used to highlight certain values on traces or to indicate limits in diagrams. The following markers are available:

- Normal marker
- Delta Normal Marker
- Vertical Line
- Horizontal Line

Normal Markers

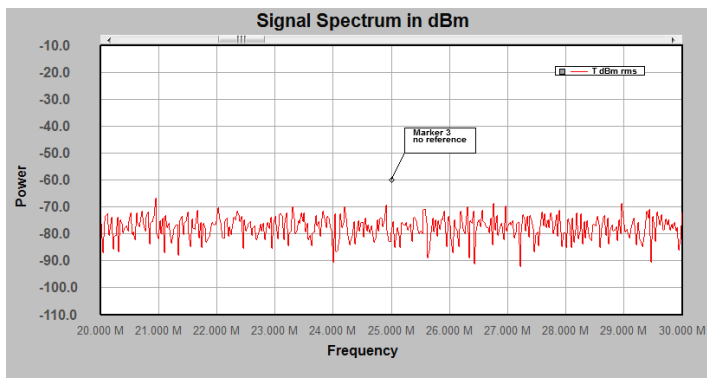

Figure 3-29 Normal Marker without reference

A Normal marker can be added using two methods:

- Menu: Marker-> Add Marker
- <CTRL> + M key

A normal marker consists of two components: The box and the reference line, with a little rectangle at the end.

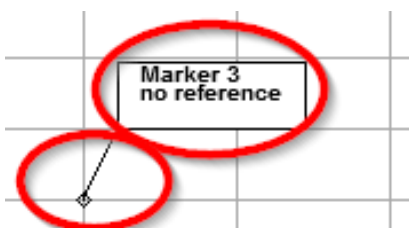

Figure 3-30 Marker components

Both components can be selected and moved. To pick the reference line component, click onto the little rectangle.

The box can be moved to a suitable location on the diagram, while the little rectangle can be dragged to and along a trace, with the marker always jumping to the trace that is closest to the little rectangle. The reference line connects the tiny rectangle to the marker information box.

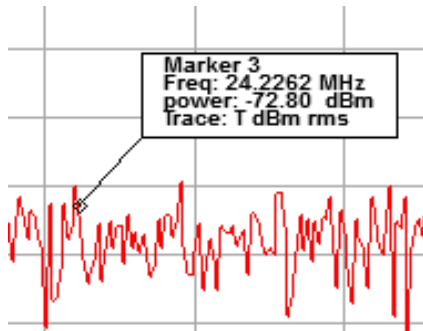
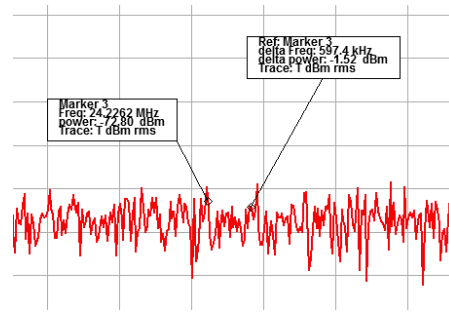

Figure 3-31 Marker locked to a trace



Marker and Delta Marker locked to the same trace

To move the marker to another trace, simply click onto the little rectangle and drag it to the desired trace. Once it gets near, it will snap to the trace.

To create a regular delta marker:

- Menu: Marker-> Add Marker Delta
- <CTRL> + D key

The resulting delta marker will always reference the most recently created normal marker on the same trace.

The delta marker will display both the delta-X and delta-Y value. More options are accessible in the marker properties dialog, which will be detailed later.

To delete a normal marker:

- Select Delete from the context menu
- Press the Key

Markers can also be moved with the keyboard:

Select the little rectangle of the marker with the mouse.

Use <arrow left> or <arrow right>keys to move the marker.

Use <SHIFT> + <arrow left> or <SHIFT> + <arrow right>keys to move the marker in smaller steps

Use <CTRL> + <arrow left> or <CTRL> + <arrow right>keys to move the marker in very small steps

Select a marker and right-click the mouse to access the context menu:

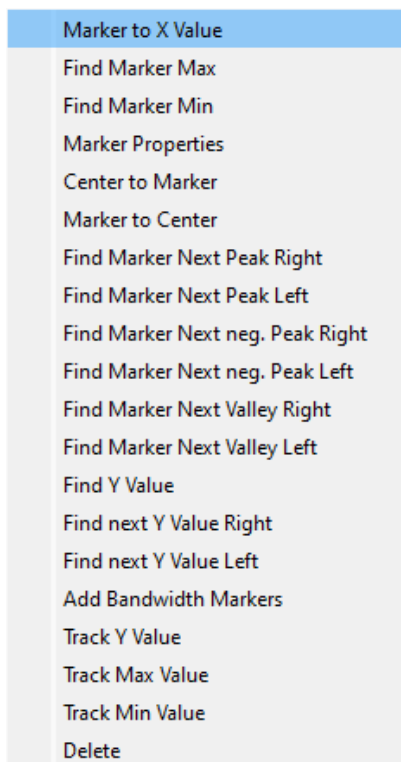

Figure 3-32 Normal Marker, Context Menu

- **Marker to X Value**
Opens a little dialog, showing the marker's current X-value. Change this value to move the marker to the desired position.
- **Find Marker Max**
The marker will move to the maximum Y value of the referenced trace.
- **Find Marker Min**
The marker will move to the minimum Y value of the referenced trace.
- **Marker Properties**
The Marker Properties Dialog will open.
- **Center to Marker**
Centers the x-axis to the current markers X-position.
- **Marker to Center**
The marker position will move to the horizontal center of the diagram.
- **Find Marker Next Peak Right**
Searches for another peak to the right of the current position.
- **Find Marker Next Peak Left**
Searches for another peak to the left of the current position.
- **Find Marker Next neg. Peak Right**
Searches for another negative peak to the right of the current position.
- **Find Marker Next neg. Peak Left**
Searches for another negative peak to the left of the current position.
- **Find Marker Next Valley Right**

Searches a local minimum between two peaks to the right of the current marker's X-position.

- **Find Marker Next Valley Left**

Searches a local minimum between two peaks to the left of the current marker's X-position.

- **Find Y-value**

Opens a dialog box asking for a Y-value. Searches the diagram from left to right for the selected value and, if found, place the marker there.

- **Find next Y value right**

Opens a dialog box asking for a Y-value. Searches the diagram from the current markers X-position to the right for the selected value and, if found, place the marker there.

- **Find next Y value left**

Opens a dialog box asking for a Y-value. Searches the diagram from the current markers X-position to the left for the selected value and, if found, place the marker there.

- **Add Bandwidth Marker**

Opens a dialog box, by default set to -3 (for -3dB bandwidth). It is assumed that the current marker is positioned on the peak of a resonance or filter center frequency. Delta markers are added to the right and left side of the current marker, with their Y-value matching the offset specified in the dialog box.

- **Track Y-value**

During continuous measurements, the marker will aim to keep its Y-value at the current level, and the x position will automatically update at each sweep.

- **Track max value**

During continuous measurements, the marker will aim to keep its Y-value at the maximum level and the X-position will automatically update at each sweep.

- **Track min value**

During continuous measurements, the marker will aim to keep its Y-value at the minimum level and the X-position will automatically update at each sweep.

- **Delete**

Deletes the current marker. This option is disabled for particular markers in specific applications, such as the trigger level marker, for example.

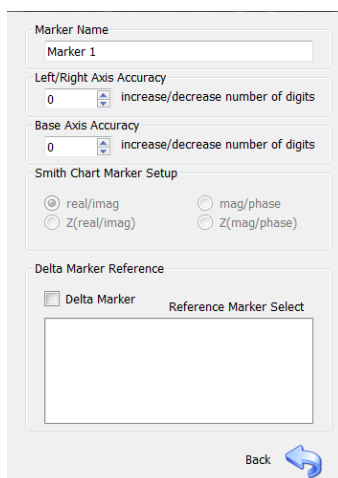

Figure 3-33 Marker Properties dialog

Use the Marker Properties dialog to edit the following marker settings:

- Marker Name
- Axis Accuracy (Display more or less decimals)
- In Smith Charts: Unit of the reflection coefficient (disabled)
- Turn a marker to a delta marker and select the reference marker from a list.

Vertical Line:

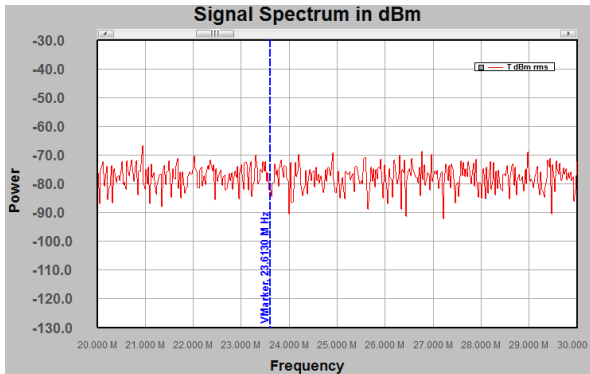

Figure 3-34 Vertical line

To make a vertical line, select the menu:

Marker -> Add Marker VLine

The vertical line can be dragged to any desired X-value, and the current X-value will be displayed along the line. The context menu will allow you to open the properties dialog or delete the marker.

Marker -> Add Marker VLine Delta

adds a Delta Marker vertical line. The most recent Vline Marker is used for reference. Using the properties editor, other VLine Markers can be selected as reference.

Markers can also be moved with the keyboard:

Select the little rectangle with the mouse.

Use <arrow left> or <arrow right>keys to move the marker.

Use <SHIFT> + <arrow left> or <SHIFT> + <arrow right>keys to move the marker in smaller steps

Use <CTRL> + <arrow left> or <CTRL> + <arrow right>keys to move the marker in very small steps

Horizontal Line:

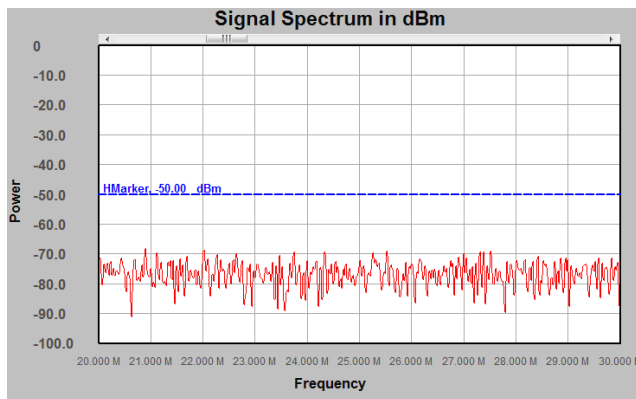

Figure 3-35 Horizontal line

To make a horizontal line, select the menu:

Marker -> Add Marker HLine Left

or

Marker -> Add Marker HLine Right (referenced to the right axis if available)

The horizontal line can be dragged to any desired Y-value, and the current Y-value will be displayed along the line. The context menu will allow you to open the properties dialog or delete the marker.

Marker -> Add Marker HLine Delta left

Marker -> Add Marker HLine Delta right (referenced to the right axis if available)

adds a Delta Marker horizontal line. The most recent Hline Marker is used for reference. Using the properties editor, other HLine Markers can be selected as reference.

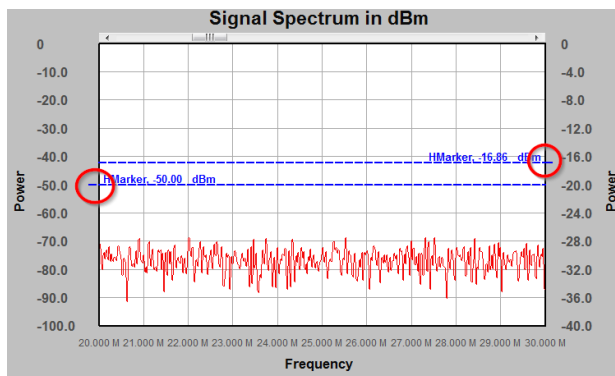

Figure 3-36 Horizontal line on diagram with two Y-axes

With two y-axes enabled, extending the HLine Marker to the left or right side will indicate which axis the marker is referring to.

The Marker menu includes the following additional functions:

- Delete Marker (deletes selected marker)
- Marker find max (finds maximum of currently selected normal marker)
- Marker find min (finds minimum of currently selected normal marker)
- Marker to center
Centers the x-axis to the current marker's X-position

Markers can also be moved with the keyboard:

Select the little rectangle of the marker with the mouse.

Use <arrow left> or <arrow right>keys to move the marker.

Use <SHIFT> + <arrow up> or <SHIFT> + <arrow down>keys to move the marker in small steps

Use <CTRL> + <arrow up> or <CTRL> + <arrow down>keys to move the marker in very small steps.

3.7 Remote Control Commands

Remote control commands are sent via a simple connectionless UDP-protocol based text format. Each command must be terminated with a "new line" character. The analyzer will respond using the same UDP protocol but a different port, as configured in the remote control setup tab.

Some commands are divided into functional chapters and each level of the hierarchy is separated by a ":" character. For example **MODE:SWP** or **TG:ON**

Query commands conclude with a question mark, such as: **IDN?**

Frequency values must be in the format **100Hz**, **10kHz**, **1MHz**, values without units will be treated as **Hz**. Power values must be in the format **-10dBm**, **5dBuV**, **0.1V**, **0.3Vpp**, values without units will be treated as **dBm**.

Syntax: **IDN?**

Description:

Will query the Analyzer Name and Version.

Result:

Text String: **TBMR-110M Vx.y.z**

Syntax: **DISPLAY:line_number:val1:val2:val3:.....val480**

Description:

This command will transfer one screen-line of the auxiliary display into the display bitmap buffer. The command starts with the line number in HEX, where the line number can be 0 to 319 aka: 0x0000 - 0x013F in hexadecimal numbers. a line number of 319 would be stated as 013F. Following the line number are 480 colon separated 8 digit Hex-values for each display pixel. While the color encoding will be 8 Bit RGB and so 00RRGGBB in hex. The display size is 480 x 320 pixels.

Result: none

Syntax: **DISPLAY:SHOW**

Description:

This command will transfer the previously buffered screen data into the displays memory and so display the uploaded data

Result: none

Syntax: MODE:<mode>

Description:

This command will set the sweep mode of the analyzer. Valid modes are:

SWP : normal sweep
FFT : short time FFT
PAR : direct parallel sweep
? : Query, will return the current mode

Result: On query, returns current mode.

Syntax: TG:<mode><optional data>

Description:

This command will set the generator:

ON : normal switch on tracking generator
OFF : switch off tracking generator
FREQ <frequency> : Set Frequency (values according to described format)
POW <power> : Set TG power (values according to described format)
FREQ? : Returns currently set frequency
POW? : Return currently set power

Result: On query, returns current settings.

Syntax: FREQ:<mode><optional data>

Description:

This command will set the Analyzers frequency range:

STAR <frequency> : Start frequency (values according to described format)
STAR? : Query start frequency
STOP <frequency> : Stop frequency (values according to described format)
STOP? : Query stop frequency
CENT <frequency> : Center frequency (values according to described format)
CENT? : Query center frequency
SPAN <frequency> : Frequency span (values according to described format)
SPAN? : Query frequency span

Result: On query, returns current settings.

Syntax: SENS: <mode><optional data>

Description:

This command will setup the analyzer sweep and detectors:

PNTS <number> : Sets the number of points per sweep
PNTS? : Query number of points per sweep
DET:FUNC <detector> : Sets the current detector
NEG = negative peak
POS = positive peak
RMS = RMS value
AVER = Average
QUAS = Quasi Peak
AVEMI = CISPR Average
DET:FUNC? : Returns currently selected detector

Syntax: BAND: <mode><optional data>

Description:

This command will setup the analyzers bandwidth:

BWID <bandwidth> : Sets the analyzers resolution bandwidth (according specified format)
BWID? : Query current RBW
VID <bandwidth> : Sets the analyzers video bandwidth (according specified format)
VID? : Query current VBW
VID:AUTO:<mode> : Sets auto video bandwidth with mode to be ON or OFF
VID:AUTO? : Returns Video bandwidth auto state

Result: On query, returns current settings.

Syntax: UNIT: <mode><optional data>

Description:

This command will setup the analyzers output data unit:

POW <unit> : Sets the analyzers data output unit format:
dBm = dB Milliwatt
dBuV = dB Microvolts
V = Volts effective
dBm1Hz = dBm per Hz
POW? : Returns currently selected output unit

Result: On query, returns current settings.

Syntax: POW: <mode><optional data>

Description:

This command will setup the analyzers attenuator:

- ATT <unit> : Sets the analyzers attenuator:
Values from - 30 dB (= 30 dB Gain) to 30 dB (= 30 dB attenuation) in 10 dB steps are valid values. Values can be given in numbers like 20, 10 or with dB like 10dB, 20dB
- ATT? : Returns currently selected Attenuator value

Result: On query return current settings.

Syntax: INIT: <mode>

Description:

This command will start a measurement or data transfer:

- IMM : This command will start a measurement and return immediately.
The interface is not blocked during a measurement.
- DATA : This command will return data
The number of data points is setup with the point command
The detector and output unit are selected with previous commands.
Data is sent without units as plain numbers, separated by a new-line character.

Prior to reading fresh data, a measurement must be completed (use the STAT command to query during a measurement). All detectors work simultaneously, but only one can be selected to be applied to the output data. However, the detector can be changed and output data read again. Consequently, only one sweep is required even if multiple detectors are used.

Result: On DATA return current data values.

Syntax: SWE: <mode><optional data>

Description:

This command will setup the analyzers sweep time:

- TIME <time value> : Sets the analyzers sweep time, valid units are s, ms, us, for example 10s, 20ms, 1000us.
- TIME? : Returns current sweep time
- TIME:AUTO<mode> : Enables or disables Auto Sweep time, valid options are ON or OFF
- TIME:AUTO? : Returns status of Auto sweep time (on or off)

Please note that video bandwidth and sweep time influence each other both or none can be set to

auto and the analyzer will try to figure out the best setting. A longer sweep time will reduce video bandwidth. While a bigger video bandwidth will reduce sweep time and vice versa.

Result: On query return current settings.

Syntax: STAT: <query value>

Description:

This command will return different status variables:

- MRUN? : will return if a measurement is in progress. Return values are YES or NO
- MERR? : will return if last measurement finished with an error. Return values are YES or NO
- MOVLD? : will return if last measurement finished with a signal overload. Return values are YES or NO
- MSTOP? : will return if a measurement stop request is pending. Return values are YES or NO
- READ? : Will return the number of data elements which are ready for read-out
- CONN? : Will return the status of the USB connection, valid answers are YES or NO

Syntax: SYS:MSTOP

Description:

Issues a stop request for the current measurement.

Result: none

Syntax: SYS:CONN

Description:

Tries to establish a connect on the USB bus, if device is not connected

Result: none

Syntax: SYS:QUIT

Description:

Will quit the remote control application

Result: none

Syntax: SYS:OVRESET

Description:

This will reset a pending overload condition (beep in instrument)

Result: none

Syntax: SYS:FLT <filter mode>

Description:

This command will setup the analyzers RBW filter definition type:

3dB : sets filter to 3 dB mode

6 dB : sets filter to 6 dB mode

Syntax: EMI: <mode><optional data>

Description:

This command will setup the analyzers EMI detector configuration:

TAUR <rise time> : Will set up the quasi-peak detector rise time in s, ms, or μ s

TAUF <fall time> : Will set up the quasi-peak detector fall time in s, ms, or μ s

TAUM <meter τ > : Will set up the meter τ

Please consult CISPR 16-1-1 documentation for further explanation.

Result: On query, returns current settings.

4 Specifications

Parameter	Description	Value/Range	Remark
Operating Voltage	Mains Voltage Range	100-120 VAC / 200 - 240 VAC, 50-60 Hz	Mains voltage selection switch
Operating Temperature		0 °C – 40 °C,	
Storage Temperature		-20 °C – 60 °C	
Frequency Range	Oscilloscope	DC - 110 MHz	True DC coupled
	Spectrum Analyzer	1 Hz - 110 MHz	Max. 0V DC
	EMI Analyzer	1 Hz - 110 MHz	Max. 0V DC
	Tracking Analyzer	1 Hz - 110 MHz	Max. 0V DC
Reference Frequency accuracy	Initial accuracy after 30 minutes warm-up	+/- 10 ppm	
RF Input connector		50 Ohm, Type-N	
RF input VSWR		< 1 : 1.15	10 ... 30dB att.
		< 1 : 1.5	0 ... 30dB gain
Maximum RF input level	Attenuation / gain	+30 dBm/137dB μ V/7V	20dB/30dB att.
	dependent	+25 dBm/132dB μ V/4V	10 dB att.
	Negative att. = gain	+15 dBm/122dB μ V/1.25V	0 ... -30dB att.
Input RF attenuator		0 - 30 dB in 10 dB steps	
Input LNA		0 - 30 dB in 10 dB steps	
Amplitude Accuracy	DC - 110 MHz	Better +/- 0.8 dB	at 18°C - 28°C
Noise (DANL)	f = 10 Hz	- 132 dBm typ.	RBW = 1Hz
	f = 100 Hz	- 144 dBm typ.	RBW = 1Hz
	f = 1 kHz	- 149 dBm typ.	RBW = 1Hz
	f = 10 kHz	-156 dBm typ.	RBW = 1Hz
	f = 100 kHz	- 160 dBm typ.	RBW = 1Hz
	f > 1MHz - 110 MHz	- 162 dBm typ.	RBW = 1Hz
Intercept Point 2	f = 10 MHz	+ 50 dBm typ.	ATT = 0 dB
Intercept Point 3	f ₁ = 32 MHz, f ₂ = 33 MHz	+ 43 dBm typ.	ATT = 30 dB
		+ 24 dBm typ.	ATT = 0 dB
		- 6 dBm typ.	ATT = -30 dB
Resolution Bandwidth		0.1 Hz - 3.5 MHz	arbitrary
Video Bandwidth		0.1 Hz - 3.5 MHz	arbitrary
Pre-Selector Filter Bank		7 Bands + Bypass	6th order band-pass
Sampling Rate		250 MSPS, 14 Bit	
Detector		RMS, pos./neg. Peak, Average, Quasi Peak, CISPR Average, CISPR RMS.	According to CISPR-16-1-1 and Mil Std. 461
Processing		Sweep, STFFT, parallel sweep	
Tracking Generator frequency stability		+/- 25 ppm	
Tracking Generator amplitude stability		better +/- 0.5 dB	
Tracking Generator amplitude range	DC - 100 MHz	-50 dBm to 0 dBm	
	100 MHz - 110 MHz	-50 dBm to -10 dBm	

Attenuation [dB]	Absolute Max. Input Level [dBm, dB μ V, V]
30	30 dBm, 137 dBuV, 7 V
20	30 dBm, 137 dBuV, 7 V
10	25 dBm, 132 dBuV, 4 V
0	15 dBm, 122 dBuV, 1.25 V
-10 (equivalent 10dB gain)	15 dBm, 122 dBuV, 1.25 V
-20 (equivalent 20dB gain)	15 dBm, 122 dBuV, 1.25 V
-30 (equivalent 30dB gain)	15 dBm, 122 dBuV, 1.25 V

5 Ordering Information

Part Number	Description
TBMR-110M-EU TBMR-110M-UK TBMR-110M-US TBMR-110M-AU	TBMR-110M EMI-analyzer, DC – 110 MHz; USB cable country specific IEC power cord and mains voltage setting TBFL1 attenuator / high pass filter / transient limiter USB stick containing the TBMR-110M software, EMCview software and manual Quick start guide

6 History

Version	Date	Application software version	Changes
V1.0	19.4.2024	V1.2	Initial document

The application software version refers to the most recent version available at the time of writing the operating manual.